

PRODUCT CATALOGUE

2 0 2 0 - 2 0 2 1

Page Index

Bantex Section.....	07-132
Oxford Section.....	132-152
XYRON Section.....	153-154
Papeo Section.....	155-159
APLI Section.....	160-172
3L Section.....	173-175
LINEX Section.....	176-196

1-9

2B Pencils.....	113
3 Holes & 4 Holes Perforator.....	120
3-Tier Multi Pocket.....	125
4-Tier Multi Pocket.....	125
747 Products.....	84-87

A

A2, A3, A4, A5, FC, LS Pocket	52-54
A4 Adhesive Pocket.....	58
A4 Computer Labels (APLI).....	162-170
Acrylic Suspension Box.....	80
Active Book; Oxford.....	149-151
Alphabetical Indexes.....	61
Alluminium Ruler.....	186
APLI Basic.....	163
Architecture Templates.....	181
Art Knives & Cutting Knives.....	177-178
APLI Basic Flexy.....	171-172

B

Banded Insert Ring Binder-Notes.....	28-29
Black Board Set.....	190
Black'n Red Notebook; Oxford.....	142-144
Blister pack, APLI Labels.....	169, 171-172
Block Notes.....	38, 39
Box Series, Fancy & Natural (Papeo).....	155-159
Business Card (APLI).....	165
Business Card Cases.....	126
Business Card Album.....	85, 127
Business Card Holder.....	114-115
Business Card Pocket.....	56
Business Card Pocket - Adhesive.....	58
Business Signature Notebook; Oxford.....	138-141

C

Cardboard Dividers.....	60-61
Cardboard Document File.....	103
Card Holder.....	56, 114-115, 128
Card Dispenser.....	128
CD Pocket - Adhesive.....	58
Children Desk Pads.....	49
Circle Templates (Linex).....	181
Clipboard.....	44-48
Clip File.....	76
Clipholder.....	85
Clip Strips (3L).....	174
Collector Pocket.....	57
Curve Set.....	191
College Set Square.....	189
Colour Dividers PP.....	63
Colour Paper Clip.....	113
Compass (jangka).....	193
Compass Cutter.....	178
Compressor.....	21
Computer / Data Ring Binder.....	27
Computer File.....	26
Conference Case.....	84, 87
Continuous Form Label (APLI).....	161
Cutting Mats, Set.....	180

D

Data Binder / Computer Binder - 22 Poles	27
Dagadu Series.....	40-41
Desk Organizer.....	111
Desk Pad 747.....	86
Desk Pad, Desk Pad with Map.....	49
Display Books	68-72
Divider Cardboard.....	60-61
Divider Maxi.....	63
Divider PP.....	62-63
Divider Strongline For Multiring Binder B5.....	34-35
Document Files.....	99
Document Pocket with Flap.....	55
Document Portfolio.....	91
Document Tray Optima.....	82
Document Wallet PP.....	102
Drawer Organizer.....	110
Drawing Pencils.....	193
Drawing Tube.....	191
DVD Pockets - Adhesive.....	58
DVD Insert Binder.....	30

E

Easy Box.....	90
Elegant CD Boxes (Papeo).....	158
Eraser Shield (Linex).....	192
Essential Notebook (Oxford).....	136-137
Exclusive Fancy Clipboard.....	44
Exclusive Clipboard with Cover.....	48
Exclusive Display Book Hard Cover.....	71
Exclusive Padfolio.....	50
Exclusive Multiring Binder.....	32
Expandable Pocket.....	54
Expanding File For Cheque.....	95
Expanding File with Zipper Pocket.....	94
Expanding File PP.....	97
Expanding File with Handle.....	96

F

Fancy Box Series.....	156
Fancy Multiring Binder (Dagadu).....	40-41
Fancy Stripes Series.....	130-131
Filing Strips - Adhesive.....	59
Flat Scale.....	187
Flexible Curve.....	191
Flexy Notes.....	106
Flexy Tabs.....	107
Flipover Presentation Binder.....	66-67
Fluorescent Yellow Promotional Label (APLI).....	168
Folder / Letter File.....	102
Folded A3 Pocket.....	53
Form Up.....	124

G

Geometry Set Square.....	188
Glasseque Desk Accessories.....	123
Glue Stick.....	109
Go-Fix Suspension Filing Rack.....	81

I

ID Card.....	114-115
ID Tag.....	175
Indexes Alphabetical.....	61
Index L Folder.....	98
Index Strongline.....	64-65
Index Tabs (Bantex).....	59
Ink Jet Photo Paper.....	105
Insert Display Book.....	70-71
Insert DVD / CD Binder.....	30
Insertion Filing Strip.....	77
Insert Ring Binder A4, A5, Folio.....	24
Insert Post / Pipe Binder.....	25

J

Jangka (Compass).....	193
Jolly Bright Series.....	132
Jumbo Knock Down - Magazine File.....	89

L

L Folder & Snap Folder.....	101
Label APLI.....	160 - 172
Label Holders.....	174
Laminated Ring Binder.....	23
Letter Size Pockets.....	52
Lever Arch File Economic.....	19
Lever Arch File Glossy.....	18
Lever Arch File PP.....	10-11
Lever Arch File PVC.....	12-13
Lever Arch File Trendy.....	16-17
Lever Arch File Two Tone.....	14-15
Letter Tray.....	83
Lettering Stencils.....	182-185
LINEX Nautical.....	194-196
Loose Leaf.....	37



M

Magazine Files.....	89-91
Manager File.....	75
Matt Coated Ink Jet Paper.....	105
Maxi Divider & Index PP.....	63
Mechanical Pencils.....	193
Memo Cube Acrylic, Refill.....	128, 129
Memo Glass.....	107
Menu Cover.....	86
Meeting Book (Oxford).....	146-147
Mini Punch.....	122
Mini Stapler.....	119
Mouse Pad.....	50-51
Multi L Folder.....	98
Multiholes Zip Pocket.....	36
Multimedia - CD or DVD Labels (APLI).....	166
Multiring Binder A5, B5.....	33
Multiring Binder Dagadu.....	40-41
Multiring Binder Fancy.....	42
Multiring Binder Jalak Putih.....	43
Multiring Binder PP.....	31

N

Name Card Holder.....	126
Nautical Plotter.....	195
Nautical Protractor.....	195, 196
Nautical Set Square with Handle.....	196
Notebooks (Oxford).....	133-137
Note Pad (Oxford).....	151
Numerical Indexes.....	62

O

Office Pencils.....	192
Office Perforator.....	120-121
Organizer & Signature.....	73
Oxford International.....	145-152

P

Padfolio.....	50
Paket Ujian.....	46-47
Paper Clip.....	113
Parallel Ruler (LINEX).....	195
PCB Transfer Paper (PAPEO).....	159
Perforator.....	120-121
Personal Document.....	88
Pocket for Display Book - Refillable.....	72
Pocket for Flipover Presentation Binder.....	67
Pockets for Multiring Binder.....	35
Pocket Stapler.....	117
Pocket with Side & Top Opening.....	52-54
Pocket with Side Opening.....	54
Pockets A2, A3, A4, A5.....	52-54
Poly Wallet.....	93
Polyester Transparent Label (APLI).....	167, 169
Portable Case with Handle.....	92
Post / Pipe Binder.....	25
Presentation Folder.....	75
Prong Paper Fasteners.....	77
Punchless Binder.....	23

Q

Quick Acting Bow Compass.....	193
Quotation Folder.....	74-75

R

Real Size APLI Label.....	170
Reference Number.....	200-201
Refill Memo Paper.....	159
Reinforcement Ring.....	109
Ring Binder 747.....	85
Ring Binder A2&A3 - Landscape.....	22
Ring Binder A2&A3 - Potrait.....	22
Ring Binder A4 & Folio.....	21
Ring Binder A5.....	20
Rulers.....	186-190

S

Sales & Conference Case.....	84
Sales & Order Case.....	87
School, Drawing & Office Ruler.....	187
Self Adhesive Filing Strip.....	77
Self Adhesive Labels Computer (APLI).....	160-172
Set Square.....	189
Signal Pockets.....	57
Signature Book.....	73
Signature Notebook (Oxford).....	140-141
Slanted Sign Holder.....	124
Snap Folder & L Folder.....	101
Snap Folder Landscape.....	100
Soft Cover Journal (Oxford).....	140
Sorter Book.....	73
Spare Knives.....	179
Stand Up Sign Holder.....	124
Standtall Display.....	125
Staple Remover.....	118, 119
Stapler.....	116-117
Staples.....	118
Stitching Artist Portfolio Cases.....	104
Super Rulers.....	186
Suspension File.....	78, 81
Suspension Filing Box / Case.....	80
Suspension Filing Tray.....	79
Suspension Filing Trolley.....	27

T

T - Square Set (LINEX).....	190
Tack-All.....	108
Tailor Set Square (LINEX).....	192
Tape Dispenser.....	112
Telephone & Address Book.....	86, 127
Tissue Dispenser.....	129
Transparent Display Book.....	72
Transparent Polyester/weatherproof labels.....	167
Triangular Scale Ruler (LINEX).....	188
Twin Tabs (Bantex).....	59

U - V

Urban Mix Notebook (Oxford).....	134-135
Useful Information.....	2-6

W

Waste Paper Basket.....	112
White Polyester/Weatherproof.....	168
Word Processor Rulers.....	187
Wrist Support, Gel.....	51
Writing Case.....	87

XYZ

Zip Pocket.....	55
-----------------	----

Note

The price list on this catalogue is valid only for delivery in Jakarta areas. Prices, colours, models & specification can be changed without prior notice.

Catatan

(Harga di katalog ini berlaku untuk pengiriman di Jakarta dan sekitarnya. Harga, warna, model dan spesifikasi dapat berubah sewaktu-waktu tanpa pemberitahuan terlebih dahulu.)

Bantex
Organizing Made Easy





LAF/ Ordner sesuai untuk menyimpan berkas terjilid secara efisien, misalnya:

- Berkas yang sering digunakan seperti daftar harga, surat penawaran, lembar penilaian, dan lainnya.
- Berkas-berkas untuk konsultan pajak, pengacara, kantor pemerintah dan kantor- kantor lainnya.
- Rekening koran, air dan listrik.
- Nota-nota, surat jalan, invoice dan kwitansi.

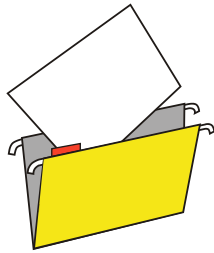

Suspension File sesuai untuk menyimpan berkas terurai secara efisien, misalnya:

- Berkas yang dikelola di dalam satu department administrasi, terutama bagian pembelian, penjualan dan sekretariat.
- Berkas dalam pola proses dan penanganannya harus segera.
- Maksimal 60 lembar dalam sebuah map gantung
- Setelah 30 - 60 lembar diletakkan dalam folder, dapat dipindahkan ke map gantung.



..... are distributed by Bino & also available here:



Active & In active File

Kriteria dari pola penyimpanan berkas:

1. Keputusan dalam menentukan penyimpanan secara terjilid atau lembaran lepas
2. Tipe dan jenis berkas (berkas aktif / in aktif)
3. Lamanya penyimpanan berkas
4. Informasi tentang ruang dan rak yang akan dibutuhkan

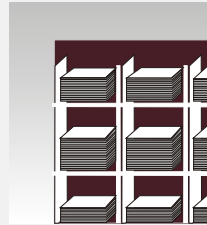

Untuk dokumen posisi tidur gunakan Letter Tray

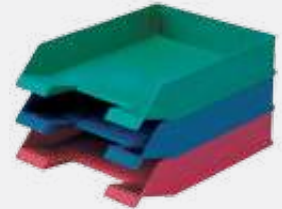

On Progress Files

File yang sangat aktif dan sering digunakan:

- Folder: holds up to 30 sheets
- Suspension File: holds 30-60 sheets or several folders can be put inside
- Letter tray: holds hundreds of sheets, or many folders can be put inside

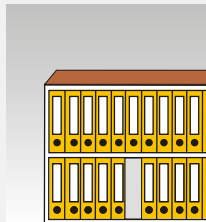

Untuk dokumen posisi berdiri gunakan Lever Arch File



Active Files

File cukup aktif, penggunaannya secara regular:

- Lever Arch File : kapasitas 5 and 7 cm
- Computer File : kapasitas 3 cm
- Post Binder : kapasitas 6, 8 and 10 cm

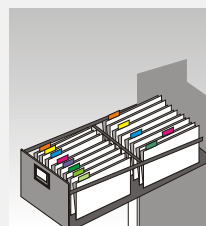

Untuk dokumen posisi gantung gunakan Suspension File

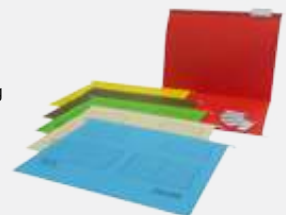

In Active Files (bound files)

- File diperlukan hanya dalam waktu- waktu tertentu, umumnya untuk seminar dan data
- Ring Binder: capacities 2 to 6,5 cm
- Insert Ring Binder: capacities 2 to 6,5 cm

Colour Codes

Each product is specified by a 4-digit ref. No. And the colour is specified by 2 additional digits. Example: Lever Arch File no. 1450 in red = 1450-09

Setiap produk kami memiliki 4-digit nomor (item produk). Identifikasi warna ditunjukkan dengan tambahan 2 angka dibelakang setiap produk. Contoh: Ordner (LAF) nomor 1450 merah = 1450-09.

Sky.Blue 23	Cool.Aqua 76	Musky.Pink 74
Cobalt.Blue 11	Turquoise 22	Pink 19
Blue 01	Pistachio 72	Melon 63
Blueberry 62	Lime 65	Grape 61
Lilac 21	Grass.Green 15	Grey 05
Anthracite.Grey 25	Green 04	Silver 17
Lemon 26	Red 09	White 07
Yellow 06	Maroon 14	Transparent 08
Mango 64	Peach 45	Black 10
Orange 12	Beige 13	Assorted.Color 00

Modern colours

Bursting with energy and are ideal for creating an outgoing atmosphere in which to promote drive and forward thinking.

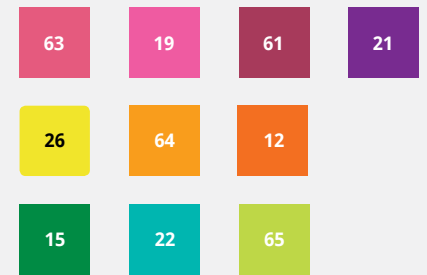

Pastel colours

Create a soft elegance, fun and innocence look. Light and easy on visual senses and have soothing quality to look at.



Traditional colours

Perfect if you wish to add a touch of colour to your everyday life and inject energy into your surroundings - without troubling the eye or disturbing mental activity.

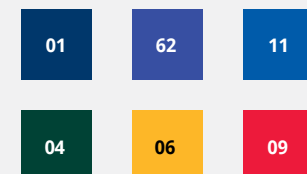

Neutral colours

Create an elegant and stylish look, they are ideal if you wish to promote profundity, peace and quiet contemplation.



Bantex A4 Ordner

~ Membuat manajemen ruang di dalam kantor anda menjadi lebih efisien ~

Ordner Bantex A4 memiliki ukuran yang lebih ramping dibanding merek lain namun memiliki kapasitas isi kertas yang sama banyaknya.

- Bantex A4: Lebar 7 cm, kapasitas 7 cm tinggi 31,5 cm

- Merk lain: Lebar 8,5 cm, kapasitas 7 cm tinggi 35 cm

Rak LAF/ordner dapat memuat Bantex A4 LAF lebih banyak dibanding LAF merk lain. Saat ini, standar kertas yang paling umum adalah A4 dan banyak digunakan dalam printer, photocopy, kop surat dan lainnya.

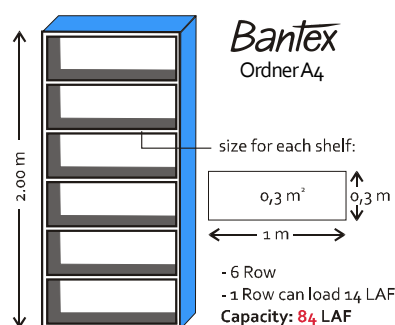
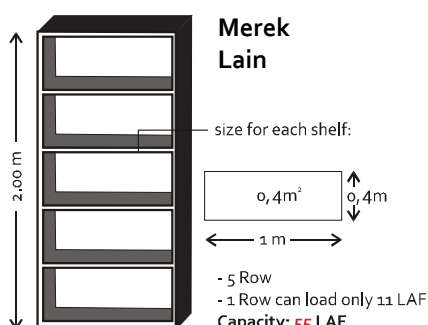

Bantex
Organizing Made Easy

Mechanism Information

Please see below how the height and the capacity are measured for each of the most frequently used mechanisms.

Di bawah ini ditunjukkan ukuran dan kapasitas mekanik yang paling sering dipergunakan.

7 cm Lever Arch File

Lever Arch ring mechanism associated with the lever Arch files come in 2 capacities, approximately holding 37mm and 57mm of paper & dividers. They come complete with a compressor, and have a lever operation for ease of opening and closing.

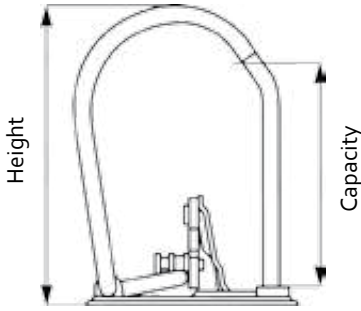

7 cm. Lever Arch File
Mekanik Ordner 7 cm

5 cm Lever Arch File

Lever Arch ring mechanism associated with the lever Arch files come in 2 capacities, approximately holding 37mm and 57mm of paper & dividers. They come complete with a compressor, and have a lever operation for ease of opening and closing.

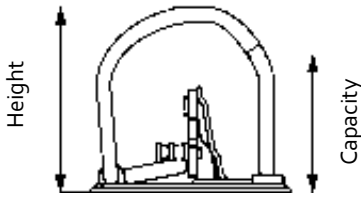

5 cm. Lever Arch File
Mekanik Ordner 5 cm (Small)

O-Ring Mechanism

The round ring or 'O' ring as it is more commonly known, is ideal for the smaller product style filo-fax files & easle binders, where it is easy to turn over pages. the 'O' ring and the 'Q' Ring, commonly available in 2/3/4/6 rings and have 4 main base lengths to accommodate A3/A4/A5 plus American Quarto & filofax sizes.

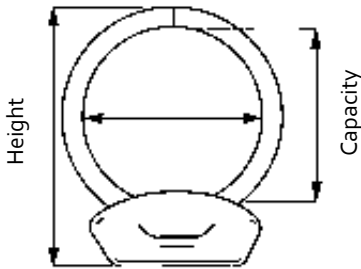

O - Ring Mechanism
Mekanik tipe O - Ring

D-Ring Mechanism

The D-Ring Mechanism is also called the Combi Mechanism because one side of the mechanism is round and the other side is square. This shape enables paper to lie flat for easy access.

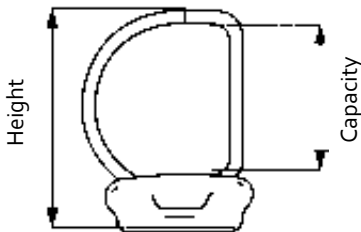

D - Ring Mechanism
Mekanik tipe D - Ring

B-Ring Mechanism

The B-Ring Mechanism is also called the Square Mechanism (Q-Ring). It is mostly used for the Data Ring Mechanism. The shape enables paper to lie flat.

B-Ring juga disebut Q-Ring (Square) atau kotak, bentuk Begel. Umum dipakai pada data mekanik. Bentuk yang siku memungkinkan penyusunan kertas secara rata.

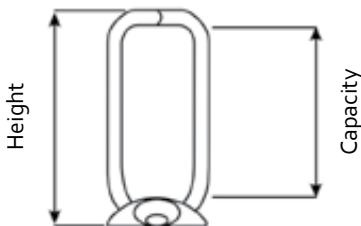

B - Ring Mechanism
Mekanik tipe B - Ring

Hole Distance Information

Please see below the most frequently used punched hole distances on paper. Bantex pockets, dividers and indexes are produced with the universal 11 punched holes fitting perfectly on the most frequently used mechanisms.

Jarak lubang yang umum dipakai, pocket, divider dan index Bantex menggunakan 11 lubang perforasi dan bisa dipakai hampir untuk segala jenis mekanik.

Hole Distance Information			
Amount of holes on the paper	Hole Distance (mm)	Paper Size	Usage Area
2	80	A4, A5	Western Europe
4	80-80-80	A4	
4	45-65-45	A5	
4	21-70-21	A4	Sweden
3	70-70	Junior Size	North & Central America
3	108-108	Letter Size	

Maxi Size

Maxi size dividers and indexes are a bit bigger than the normal A4 size. It is used together with pockets but it does not cover the index tabs.

Ukuran maxi pada divider dan index sedikit lebih besar dari A4 untuk dipakai bersama-sama dengan pocket, namun tidak menutupi tabs / index.

Polyvinylchloride (PVC)

It is a strong, flexible and durable material. Suitable for making any product.

Bahan yang fleksibel, tahan lama dan kuat. Cocok untuk segala jenis produk.

Polypropylene (PP)

It is made of environmentally friendly plastic material, very suitable for pockets, folders, indexes, etc as it does not react with any colour on photocopies and photos.

PP merupakan plastik yang ramah lingkungan. Sangat cocok untuk pocket, folder, index dan lain-lain. Tidak reaktif terhadap warna pada fotocopy atau foto. PP mengandung unsur C (karbon) dan H (hidrogen). Ketika PP dibakar hanya akan menghasilkan karbondioksida dan air. Untuk memproduksi PP tidak diperlukan bahan beracun seperti timbal. PP dibuat dari propylene monomer. Propylene monomer ini adalah limbah dari industri minyak bumi yang biasanya dimusnahkan dengan cara dibakar ke atmosfer dan akan berkontribusi pada emisi gas rumah kaca. Maka dengan banyak menggunakan produk yang terbuat dari PP, secara langsung akan mengurangi emisi gas rumah kaca, karena mengambil propylene monomer (yang tadinya hanya akan dibakar dan menjadi emisi) menjadi bahan baku untuk membuat PP dan akhirnya menjadi produk lain. Material PP 100% dapat didaur ulang.

Relation Table (Ring Size - Ring Capacity - Paper Weight - Amount of Paper)				
Mechanism Size	O-Ring Capacity	Sheets 80 gsm	D-Ring Capacity	Sheets 70 gsm
16 mm	11.5 mm	100	-	-
-	-	-	20 mm	180
25 mm	18.5 mm	160	25 mm	220
40 mm	-	-	40 mm	360
52 mm	-	-	52 mm	470
65 mm	-	-	65 mm	590

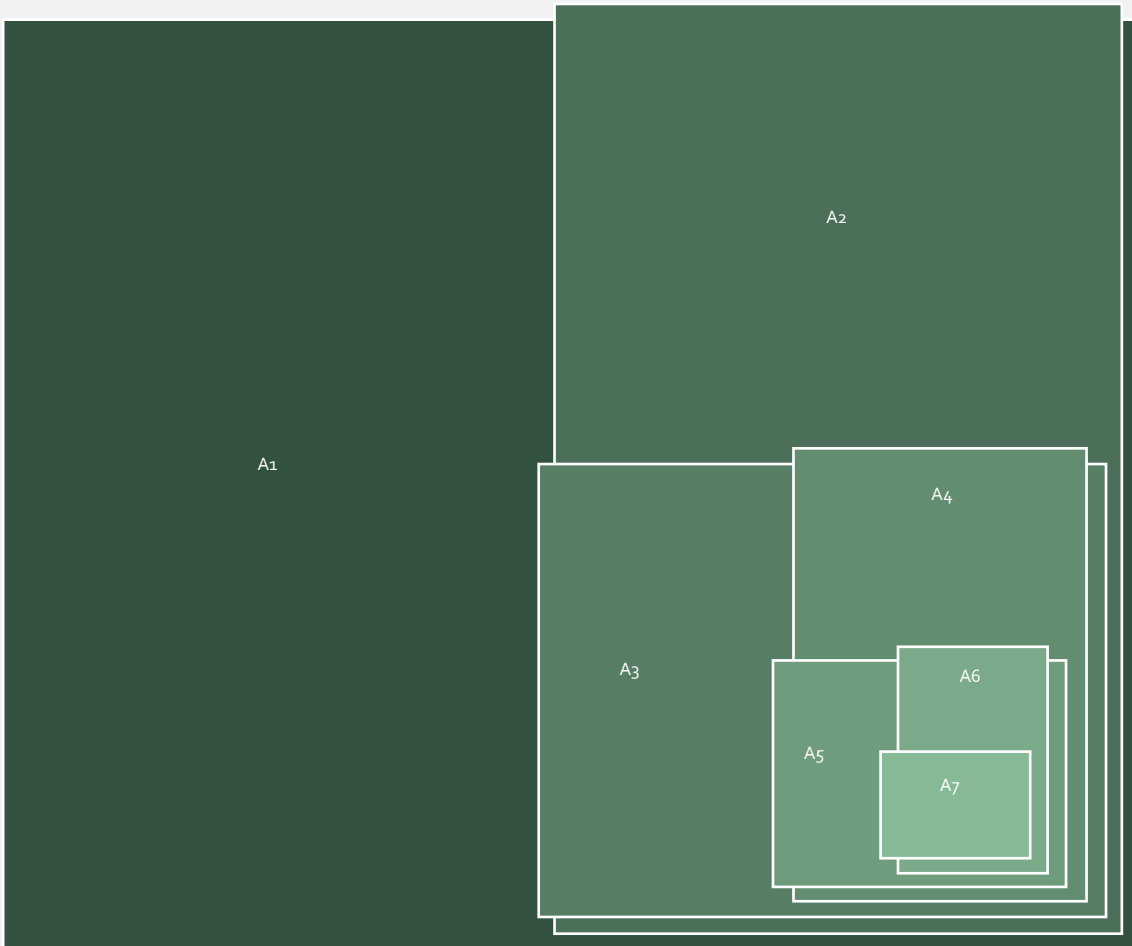

Paper Size Information

The largest cut sheet of paper in the A-size group is A0 size = 1 M². The next format is A1, half of the A0 size. Please refer to the table below. The C-size group is used for envelopes, folders, etc. Which enables the A-sizes to fit in.

Ukuran kertas potongan terbesar adalah A0 (nol) = 1 M². Perbandingan panjang sisi adalah 1 : √2. Ukuran selanjutnya adalah A1, setengah dari A0 (lihat tabel). Ukuran C dipakai untuk amplop, folder sehingga ukuran A bisa masuk.

Paper Size Information			
Division Figure	A - size (mm)	B - size (mm)	C - size (mm)
0	A0 (841 x 1189)	B0 (1000 x 1414)	C0 (917 x 1297)
1	A1 (594 x 841)	B1 (707 x 1000)	C1 (648 x 917)
2	A2 (420 x 594)	B2 (500 x 707)	C2 (458 x 648)
3	A3 (297 x 420)	B3 (353 x 500)	C3 (324 x 458)
4	A4 (210 x 297)	B4 (250 x 353)	C4 (229 x 324)
5	A5 (148 x 210)	B5 (176 x 250)	C5 (162 x 229)
6	A6 (105 x 148)	B6 (125 x 176)	C6 (114 x 162)
7	A7 (74 x 105)	B7 (88 x 125)	C7 (81 x 114)
8	A8 (52 x 74)	B8 (62 x 88)	C8 (57 x 81)
9	A9 (37 x 52)	B9 (44 x 62)	C9 (40 x 57)
10	A10 (26 x 37)	B10 (31 x 44)	C10 (28 x 40)

Other Paper Sizes

Foolscap, Folio	210 x 330 mm
Quarto	215 x 280 mm
Letter Size	216 x 279 mm

Build Your Corporate Identity

by printing your logo on *Bantex* files



We can help you build a high corporate image by printing your company's name, logo, special colours, design on our high quality Bantex files. Please select a particular file that is best suited to your needs, then give us your company's name, logo, special colours, design, and we will make the graphic artwork for you and imprint it on your selected file through the hot-printing, emboss or silk-screening processes. We can also provide you with further customization on the product according to your needs. (additional feature in your custom product, for example: name card pocket, paper pocket, several pocket in certain area, pen holder, etc). This customized product under the well-known brand of Bantex will certainly give you high values and great benefits in presenting your corporate identity that is so crucial in building a strong corporate image that public holds of your company. Make sure that the symbolic presentation of your company is printed on the Bantex brand files. Bantex products are a symbol of status in prestigious offices.

Kami dapat membantu anda membangun citra korporat yang tinggi melalui pencetakan nama perusahaan, logo, warna khas, ataupun desain dari perusahaan anda pada produk Bantex yang bermutu tinggi. Pilihlah Ordner / Binder yang sesuai kebutuhan anda, kemudian berikan logo perusahaan, nama perusahaan, warna khas atau desain khusus perusahaan anda untuk kami buat film grafis-nya dan kemudian mencetaknya pada Ordner / Binder yang anda pilih melalui proses hot-print, emboss, sablon maupun laminated. Kami juga dapat menyediakan kustomisasi/pesanan khusus lebih lanjut sesuai kebutuhan anda (misalnya penambahan kantong untuk kartu nama, penempatan kantong pada beberapa bagian tertentu, tempat pen, dsb). Produk Bantex yang dirancang khusus untuk anda ini tentu akan memberi keuntungan dan nilai lebih dalam mempresentasikan identitas perusahaan anda, yang mana merupakan faktor penting dalam membangun citra korporat yang kuat di mata publik tentang perusahaan anda. Pastikan bahwa presentasi simbolik perusahaan anda tercetak pada produk merek Bantex. Produk Bantex merupakan simbol status pada kantor-kantor prestise.





Bantex adalah merek office stationery products yang pertama kali dikembangkan di Copenhagen, Denmark pada tahun 1961 dan merupakan perusahaan pertama yang memproduksi produk ramah lingkungan di dunia. Sejak itu, Bantex menjadi sebuah merek peralatan kantor yang sangat terkenal di Eropa dan telah memberikan lisensi untuk mendistribusi dan memproduksi produk - produk dengan merek Bantex kepada distributor yang berada lebih dari 70 negara di dunia termasuk di Indonesia.

Bantex yang terkenal dengan filing products atau produk produk untuk menyimpan file dengan kualitas terbaik dan harga terjangkau telah mengembangkan pasarnya hingga ke segmen yang lebih luas lagi.

Saat ini, Bantex telah memiliki ribuan macam produk yang mencakup Office stationery, School stationery, Professional stationery dan Private Consumer stationery

Bantex



Let's Be Kind to Our Earth

Being environmentally friendly simply means having a lifestyle that are better for the environment. Its all about taking small steps towards mother earth so as to make this planet a better place for our communities and generations to come. A good way would be to start with conserving water, driving less and walking more, consuming less energy, buying recycled products, eating locally grown vegetables, joining environmental groups to combat air pollution, creating less waste, planting more trees and many more.

Here are some ways you can begin to become more environmentally friendly.

- 1. Become More Aware of Resources:** Start by living with a greater awareness of the resources that you use in your daily life. Pay attention to how you choose to heat, to travel, to use water and use products that were made by manufacturing practices. Awareness is what will allow you to then begin to make environmentally friendly choices.
- 2. Practice Conservation:** With your new awareness of how natural resources are used in your life start to practice conservation. This can be as simple as turning off the lights as you leave a room and as complex as making different choices when it comes to building your home.
- 3. Plant Trees:** Trees are necessary for us to survive. They give oxygen, fruits, clean the air, provide shelter to wildlife, prevent soil erosion. A shady landscape around your home can help you to reduce consumption of energy and keep your home cool even during summers. Plant small trees around your home, don't cut them unless it's necessary, work with local environmental groups to plant more trees and educate others about the positive aspects of it.
- 4. Conserve Water:** Water needs to be conserved as lot of energy is required to pump water from rivers or lakes into your home. Conserving water reduces the amount of energy that is needed to filter it. Few ways to conserve water are – take short showers, fix leaking pipes, keep the running tap close while you brush your teeth, recycle water in your home, use water saving appliances, collect rainwater in a rain barrel to water your lawn.
- 5. Change Your Travel Habits:** Driving and flying are two areas where you can make a real impact with environmentally friendly practices. Choose fuel efficient travel options, travel less and try to pick more direct routes to save on fuel. If your office is near your home, try to ride a bicycle instead of a car.
- 6. Use Less Fossil Fuel Based Products:** Find out what products and consumables you use that are made using fossil fuel based products and processes and use them less or replace them in your life.
- 7. Buy Locally Grown Products:** An easy way to reduce your carbon footprint is to buy locally grown products. When you shop locally instead of buying products that were shipped from far away, you are actually supporting local dairies and farms. Apart from this, you can follow organic farming practices and can grow food on your own backyard and can sell surplus to your friends.
- 8. Reduce Use of Harmful Chemicals:** Hazardous chemicals like paint, oil, ammonia and other chemical solutions when disposed openly, can cause pollution in the air and water as these chemicals can seep into the groundwater. The polluted air and water can have serious consequences on human health. They should be disposed off to a toxic waste site for safe disposal.
- 9. Composting:** Composting is an easy process that takes remains of plants and kitchen waste and converts it into rich nutrient food for your plants that helps them grow. It reduces the amount of garbage that goes to the landfills which pollutes the air. This way it proves safe for the environment.
- 10. 3 R's of Waste Hierarchy:** The 3 R's (Reduce, Reuse, Recycle) waste hierarchy is the order of priority of actions to be taken to reduce the amount of waste generated and to improve overall waste management processes and programs. Reduce simply means reducing what is produced and what is consumed. Reuse items for a different purpose instead of sending them to landfills. To recycle something means that it will be transformed again into a raw material that can be shaped into a new item. For example: Polypropylene (PP) is one of them.
- 11. Buy Recycled Products:** When you go out for shopping, try to buy and choose products from market that are made up of recycled materials with minimal packaging i.e. the product should be environment friendly. Look into manufacturing processes to check if it was made from recycled materials or the use of plastics or chemicals was involved in its production.
- 12. Stop Littering:** One of the common sight that we see everyday on streets is seeing people littering on roads. One of the ways to keep the environment and surrounding clean around you is to stop people from littering on roads. Instead, educate them to put trash and garbage in dustbins. The pile of garbage on road hampers the beauty of city and also pollutes the air.
- 13. Protect Wildlife:** Human activity is leading to extinction of endangered species and habitats. Protect places like beaches and forests that are habitats for animals. Join hands with local forest department to protect animal habitat.
- 14. Educate Others:** Educate others about the importance of living an environmentally friendly life. The more people share an awareness of the importance of the environment, the more we can do together to conserve it.

~ Each one of us can make a difference in the way we live our life dan take a role to be a solution to make this earth a better place. Let's start by using products that have the least impact environmentally ~

Bantex Green Initiatives

~ Prakarsa Untuk Peduli Lingkungan ~

Green Initiatives

Green Initiatives merupakan tema gerakan peduli lingkungan yang tengah dirintis Bantex dengan cara memulai lini produk dengan menggunakan bahan ramah lingkungan yang mudah didaur ulang.

Polypropylene (PP)

Polypropylene (PP) merupakan salah satu bahan dasar yang mendominasi pembuatan produk-produk ramah lingkungan Bantex. Penggunaan bahan baku PP akan langsung memberi dampak positif signifikan terhadap lingkungan, seperti yang terlihat dari beberapa fakta berikut:

PP mengandung unsur C (karbon) dan H (hidrogen). Ketika PP dibakar hanya akan menghasilkan karbondioksida dan air. Saat memproduksi PP tidak diperlukan bahan beracun seperti timbal. PP dibuat dari propylene monomer. Propylene monomer ini adalah limbah dari industri minyak bumi yang biasanya dimusnahkan dengan cara dibakar ke atmosfer dan akan berkontribusi pada emisi gas rumah kaca. Dengan banyak menggunakan produk yang terbuat dari PP, kita secara langsung akan mengurangi emisi gas rumah kaca, karena mengambil propylene monomer (yang tadinya hanya akan dibakar dan menjadi emisi) menjadi bahan baku untuk membuat PP dan akhirnya menjadi produk lain. Material PP 100% dapat didaur ulang dan dalam prosesnya tidak menimbulkan polusi berbahaya.

Kita dapat menemukan beberapa produk dalam katalog ini yang telah menggunakan material PP sebagai bahan bakunya. Di masa mendatang, sebagian besar produk Bantex akan beralih kepada produk-produk ramah lingkungan ini; tentunya dengan tetap mempertahankan kualitas tinggi yang selama ini menjadi standar produk-produk Bantex.



Tidak Menggunakan PVC
Reg. 12.PP/ES.06.20



Eco Friendly

New Trees for a Better Life

~ Bantex Environmental CSR ~

Bantex Supporting WWF Programs - NEW TREES

Sebagai bentuk kepedulian dan dukungan terhadap penyelamatan hutan Indonesia, mulai tahun 2012 Bantex berpartisipasi dalam program NEW TREES WWF-Indonesia. Program ini merupakan upaya rehabilitasi hutan dengan menggabungkan metode penanaman secara tradisional dan kegiatan monitoring menggunakan teknologi geotag.

Melalui program NEW TREES, diharapkan 7.000 hektar area hutan yang rusak di Sumatera, Kalimantan, Nusa Tenggara dan Papua dapat dihidupkan kembali dalam periode 5 tahun.

- Program NEW TREES akan memperbaiki ekosistem hutan, yang merupakan habitat satwa dilindungi dan daerah resapan / tangkapan air.
- Hutan yang ditanami kembali akan mampu menyerap emisi CO₂. Diperkirakan 36,84 ton/ha CO₂ akan diserap oleh pohon-pohon baru ini dalam kurun waktu 10 tahun setelah penanaman.
- Meningkatnya partisipasi masyarakat dalam perlindungan kawasan hutan, pemantauan kebakaran hutan, dan pengelolaan area tanam.
- Program NEW TREES mendatangkan alternative income bagi masyarakat sekitar hutan yang terlibat dalam kegiatan pembibitan, penanaman, perawatan, dan pemantauan pertumbuhan pohon.

Let's Be Kind to
Our Earth

~ Polypropylene (PP) Lever Arch File Series ~



Eco friendly.

Modern colours are bursting with energy and are ideal for creating an outgoing atmosphere in which to promote drive and forward thinking.



14 10 05 07

Neutral or classic colours create an elegant and stylish look, they are ideal if you wish to promote profundity, peace and quite contemplation.



04 01 11 62 09 06

Traditional colours are perfect if you wish to add a touch of colour to your everyday life and inject energy into your surroundings - without troubling the eye or disturbing mental activity.

Lever Arch File - PP

Ref	Description	Unit Price (Rp)	Available Packing
1465	Folio - 7cm capacity	39.930,-	1/15
1466	Folio - 5cm capacity	39.930,-	1/20
1450	A4 - 7cm capacity	38.940,-	1/15
1451	A4 - 5cm capacity	38.940,-	1/20
1453	A5 Kwitansi - 7cm capacity	34.760,-	1/15

Lever Arch File Polypropylene (PP)

Bantex ECO Lever Arch File made from environmentally friendly PP, on the outside with PP lining inside, which does not cause pollution when incinerated. The greyboard is recycled greyboard. The binding itself is bound like a book without any sharp, welded edges. The front is fitted with the Rado system, which ensures that the lever arch file is stable on the shelf. Metal reinforced finger ring and replaceable spine label.

Ordner ECO Bantex terbuat dari lapisan luar bahan PP yang ramah lingkungan dan lining PP di dalam. Greyboard yang digunakan merupakan bahan daur ulang. Dilengkapi sistem Rado, membuat ordner dapat berdiri kokoh dalam lemari. Terdapat lubang untuk memudahkan pengambilan dan label punggung yang dapat diganti sesuai kebutuhan.



Tidak Menggunakan PVC
Reg. 12.PPLES.06.20

Pada tanggal 21 September 2015 Bantex Lever Arch File-PP mendapatkan hak untuk menyanggah Logo Ekolabel Swadeklarasi Indonesia yang diterbitkan oleh Kementerian Lingkungan Hidup dan Kehutanan (No. Register Produk 12.PPLES.06.20) sebagai apresiasi kepada Bantex yang telah mampu mempertimbangkan aspek lingkungan pada produknya.



Polypropylene Series 4 Size Options

~ A4 (5&7cm), Folio (5cm), A5 (7cm) ~



Also available in
baseplate option



Size Comparison
7cm and 5cm

Varian Ukuran & Opsi Baseplate

Seri ordner PP Bantex kini hadir dengan beragam varian ukuran untuk memenuhi kebutuhan arsip anda; A4 - 5cm, A4 - 7cm, Folio - 5cm, Folio - 7cm, serta A5 (Kwitansi) - 7cm.

Versi baseplate kini juga tersedia untuk seluruh varian PP. Mekanik baseplate dapat dilepas - pasang serta memiliki pengunci sehingga secara struktur tetap sama kuatnya dengan mekanik yang terpasang permanen pada LAF biasa.

Penggunaan baseplate memberikan efisiensi pada saat packaging & pengiriman item, dimana pada versi biasa satu pack menampung 15 pcs sedangkan baseplate dapat menampung 30 pcs. Khusus tipe 1465 & 1450 tersedia pula opsi baseplate 50 pcs per pack.

Pastel Colours

Pastel colours create a world of soft elegance, fun and innocence. Lighter pastels can feel more airy, sometimes more uplifting, and easier on visual senses. These colors are cool and soothing. They have an aura around them which make them cozy to be within and soothing to look at.

Bantex PP Lever Arch File series now expand its color range even wider by including these 5 new pastel color options. They are: Sky Blue (23), Cool Aqua (76), Pistachio (72), Peach (45), and Musky Pink (74).



Polypropylene Series 5 New Color

~ Pistachio (72), Sky Blue (23), Peach (45),
Musky Pink (74), Cool Aqua (76) ~





Lever Arch File - PVC

Ref	Description	Unit Price (Rp)	Available Packing
1450V	A4 - 7cm capacity	38.940,-	1/15 ~ 50*
1451V	A4 - 5cm capacity	38.940,-	1/20 ~ 50*
1465V	Folio - 7cm capacity	39.930,-	1/15 ~ 50*
1466V	Folio - 5cm capacity	39.930,-	1/20 ~ 50*
1452	A5 Kwitansi - 7cm capacity	34.760,-	1/15
1467	A3 Portrait - 7cm capacity warna: 01; 10	53.130,-	1/12
1468	A3 Landscape - 7cm capacity warna: 01; 10	48.950,-	1/9

*Untuk luar kota & luar pulau item dapat dilengkapi baseplate, dengan penambahan biaya Rp 1.650,- / pcs.

*Baseplate

Item LAF dengan Baseplate adalah item Lever Arch File dengan mekanik terpisah yang dapat anda pasang sendiri dengan mudah. Tujuan penggunaan baseplate adalah efisiensi pada saat packaging & pengiriman barang, dimana satu pack LAF dengan baseplate dapat menampung 30 pieces LAF (dan mekaniknya), sedangkan satu pack LAF biasa (dengan mekanik yang sudah terpasang) maksimal menampung 15 pieces. Mekanik pada LAF dengan baseplate dapat dilepas - pasang serta memiliki pengunci sehingga secara struktur tetap sama kuatnya dengan mekanik yang terpasang permanen pada LAF biasa.

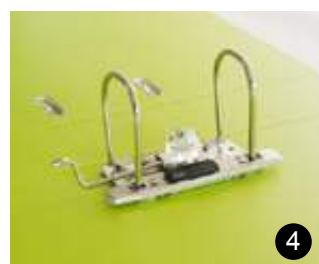



Modern colours are bursting with energy and are ideal for creating an outgoing atmosphere in which to promote drive and forward thinking.



Neutral Colours



Neutral or classic colours create an elegant and stylish look, they are ideal if you wish to promote profundity, peace and quite contemplation.

Lever Arch File - PVC

Bantex lever arch files available in many different colours and have a unique lower reinforced edge. A triple layer of sheeting provides extra protection to the files and protects surfaces of desks and cabinets from scratches. The rado mechanism locks the file closed so that it stands safely without overturning. Complete with interchangeable spine label and metal finger ring.

A3 and A5 lever arch file with reinforced lower edge, provides extra protection for the files. Available A3 and A5 size, for A5 document and filing your quittances, receipts.

Ordner / LAF Bantex PVC terdiri dari 23 pilihan warna, dilengkapi dengan mekanik pengunci rado dan diperkuat dengan lapisan ganda pada bagian bawah ordner untuk menghindari goresan pada meja/kabinet. Pengunci rado membuat ordner tidak mudah roboh. Dilengkapi pula dengan label yang dapat diganti dan finger ring untuk mempermudah pengambilan ordner pada rak/kabinet.

Ordner Bantex dalam ukuran A3 dan A5 dilengkapi finger ring. Untuk ukuran A3 tidak dilengkapi pengunci rado. Ordner ukuran A5 sangat cocok untuk menyimpan Kwitansi, surat jalan, bukti pembayaran dan dokumen/ file dengan ukuran maksimum 250x230 mm.



Traditional Colours



Traditional colours are perfect if you wish to add a touch of colour to your everyday life and inject energy into your surroundings - without troubling the eye or disturbing mental activity.



Two Tone Color Lever Arch File (Dual Color)

Bantex lever arch files now available in new attractive looks with dual two tone colours. Featured with Strongline unique lower reinforced edge. A triple layer of high quality sheeting provides extra protection to the files to ensure durability in long term use. The rado mechanism locks the file closed so that it stands safely without overturning. Complete with interchangeable spine label and metal finger ring.

Ordner Bantex kini hadir dengan tampilan warna menarik yang terdiri dari 2 kombinasi warna. Dilengkapi dengan Strongline yang memperkuat tepi bawah, terbentuk dari cover multilapis untuk perlindungan extra, memberikan kekuatan & keawetan untuk masa pakai yang panjang. Pengunci rado membuat ordner tidak mudah roboh. Dilengkapi pula dengan label yang dapat diganti dan finger ring untuk mempermudah pengambilan ordner pada rak/kabinet.



**Two
Tone
Color**





Lever Arch File - Two Tone Color Series

Ref	Description	Unit Price (Rp)	Available Packing
----- White Series -----			
1465V0709	LAF two tone FC 7 cm White/Red	39.930,-	1/15
1465V0710	LAF two tone FC7 cm White/Black	39.930,-	1/15
1465V0722	LAF two tone FC 7 cm White/Turquoise	39.930,-	1/15
1465V0762	LAF two tone FC 7 cm White/Blueberry	39.930,-	1/15
1465V0764	LAF two tone FC 7 cm White/Mango	39.930,-	1/15
1465V0765	LAF two tone FC 7 cm White/Lime	39.930,-	1/15
----- Anthracite Grey Series -----			
1465V2507	LAF two tone FC 7 cm Anthracite Grey/White	39.930,-	1/15
1465V2521	LAF two tone FC 7 cm Anthracite Grey/Lilac	39.930,-	1/15
1465V2522	LAF two tone FC 7 cm Anthracite Grey/Turquoise	39.930,-	1/15
1465V2563	LAF two tone FC 7 cm Anthracite Grey/Melon	39.930,-	1/15
1465V2564	LAF two tone FC 7 cm Anthracite Grey/Mango	39.930,-	1/15
1465V2565	LAF two tone FC 7 cm Anthracite Grey/Lime	39.930,-	1/15



Lever Arch File - Trendy
 Lever arch file with new style and modern design. With different choices of vinyl spine cover and colors and includes spine labels. Made of strong cardboard and available in folio size.

Ordner Bantex TRENDY hadir dengan style baru yang modern dalam 4 pilihan warna (hitam, biru, hijau, merah), yang semakin memudahkan dan memperluas pengelompokan berkas-berkas anda. Fitur-fitur terlengkap yang tersedia pada Bantex TRENDY akan memudahkan anda dalam aktivitas filling dan penggunaan ordner; mulai dari mekanisme pengunci Rado, mekanisme lever arch, Finger Ring, label punggung yang dapat diganti serta opsi Bantex Trendy custom dimana identitas korporat, logo atau desain anda dapat ditampilkan pada punggung ordner sesuai keinginan anda. Ordner dibuat dengan material dasar karton yang kuat dan berkualitas tinggi, memberikan jaminan keawetan dan umur pakai yang panjang.

Lever Arch File - Trendy			
Ref	Description	Unit Price (Rp)	Available Packing
1446	Folio - 7cm capacity	29.700,-	1/12
1447	Folio - 5cm capacity	29.700,-	1/12
1448	A5 Kwitansi - 7cm capacity	29.700,-	1/12

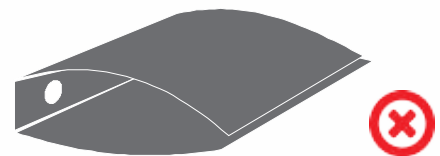

Ordner Karton Merek Lain
 Ordner karton merek lain memiliki kandungan air/kelembapan yang cukup tinggi sehingga membuatnya lebih berat dan tebal, namun tidak kuat dan tidak awet, serta mudah mengalami deformasi (perubahan berubah bentuk/ perubahan struktur membuat board melengkung)

Material Karton Berkualitas Terbaik

Material yang menjadi bahan dasar Bantex TRENDY adalah karton dengan kualitas terbaik yang kemudian diproses secara cermat dengan cara mutakhir hingga menghasilkan ordner yang tipis dan ringan, namun rigid serta kuat.

Proses produksi yang canggih dalam pembuatan Bantex TRENDY juga memungkinkan kandungan air/ kelembapan pada karton berada pada level terendah sehingga ordner tidak mudah melengkung seperti pada produk sejenis merek lain yang pada bahan kartonnya masih didapati kandungan air/kelembapan yang tinggi sehingga membuat ordner cepat berubah bentuk.

- Colours:    
 10 01 04 09

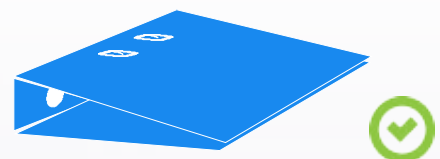

Ordner Karton Bantex Trendy
 Ordner karton Bantex TRENDY hampir tidak memiliki kandungan air/ kelembapan pada material dasarnya, sehingga membuatnya memiliki bobot lebih ringan namun kuat, rigid, awet dan tidak mudah berubah bentuk.





Mekanisme Pengunci Rado

Fitur Rado yang tidak terdapat pada merek lain membuat Bantex TRENDY mampu tetap stabil dan kokoh dalam posisi berdiri bahkan pada saat kapasitasnya terisi penuh. Produk merek lain tanpa Rado akan berubah bentuk serta tidak mampu berdiri kokoh saat terisi penuh. Selain itu fitur Rado akan mempertahankan bentuk ordner anda terkunci dalam postur yang benar sehingga Bantex TRENDY anda akan lebih awet dibanding produk sejenis merek lain.



Pocket Label

Bantex TRENDY memiliki pocket label berkualitas tinggi yang dibuat dengan presisi, sehingga memudahkan anda saat akan mengganti label punggung. Pada produk merek lain, anda akan menemui kesulitan saat mengeluarkan ataupun memasukan label punggung.



Lebar punggung tidak menentukan kapasitas tampung.

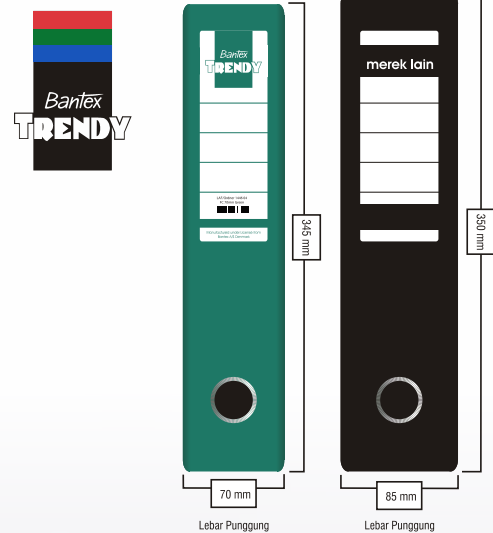

Kapasitas Tampung

Dengan dimensi punggung yang lebih kecil, Bantex TRENDY tetap memiliki kapasitas isi yang sama besarnya dengan produk merek lain yang berdimensi punggung lebih lebar. Keunggulan ini membuat Bantex TRENDY mampu mengefisienkan manajemen penggunaan ruang di setiap rak di kantor anda. Anda mendapat keuntungan penggunaan ruang yang lebih efisien dengan memakai Bantex TRENDY, karena secara kapasitas, Bantex Trendy menampung kertas sama banyaknya dengan ordner karton merek lainnya yang berdimensi lebih besar.





Lever Arch File - Glossy

Made of strong recycling cardboard wrapped by Glossy Bantex paper in one piece. Equipped with metal slot (Rado) and finger ring. Available in folio size with 7 cm and 5 cm. A5/Receipts with Lever Arch Mechanism.

Ordner karton Bantex berlapis kertas glossy, terbuat dari satu lembar karton kokoh yang dapat di daur ulang. Dilengkapi dengan pengunci rado dan finger ring untuk memudahkan pengambilan ordner pada rak / cabinet. Tersedia ukuran Folio 7 dan 5 cm. Serta ukuran A5/ Kwitansi dengan mekanik LAF.

Lever Arch File - Glossy

Ref	Description	Unit Price (Rp)	Available Packing
1441	Folio - 7cm capacity	31.350,-	1/12
1441B5	Folio - 7cm capacity / Baseplate	33.000,-	1/50
1443	A5 /Kwitansi - 7cm capacity	31.350,-	1/12

Colours: 
 10 01 11 04 06 09





Lever Arch File - Economic

Ref	Description	Unit Price (Rp)	Available Packing
1401-01	Folio - 7cm capacity	28.600,-	1/12/15
1401-10	Folio - 7cm capacity	28.600,-	1/12/15
1402-10	Folio - 5cm capacity	28.600,-	1/12/20
1403-10	A5 /Kwitansi - 7cm capacity	28.600,-	1/12

Lever Arch File - Economic

Made of strong recycling cardboard wrapped by Bantex paper in one piece. Equipped with metal slot (Rado) and finger ring. Available in folio size with 7 cm and 5 cm. A5/ Receipts with Lever Arch Mechanism.

Ordner karton Bantex berlapis kertas, terbuat dari satu lembar karton kokoh yang dapat di daur ulang. Dilengkapi dengan pengunci rado dan finger ring untuk memudahkan pengambilan ordner pada rak / cabinet. Tersedia ukuran Folio 7 dan 5 cm. Serta ukuran A5/ Kwitansi dengan mekanik LAF.





A5 Ring Binders

Ring Binder made of one piece solid board, PVC covered, glued and welded. In A5 size, spine with pocket and label.

Ring Binder yang terbuat dari bahan cardboard yang solid, dilapisi PVC, dilem dan las. Ukuran A5, dengan punggung yang dilengkapi kantong dan label.



Ring Binder A5			
Ref	Description	Unit Price (Rp)	Available Packing
8214	1321S A5 - 2 O / 20 mm Colors: 01, 05, 09, 10, 11	19.800,-	1/25
8221	1222S A5 - 2 D / 25 mm Colors: 01, 05, 09, 10, 11, 61, 62, 63, 64, 65	20.790,-	1/25
8224	1322S A5 - 2 O / 25 mm Colors: 01, 05, 09, 10, 11	20.570,-	1/25

Colours: 
65 64 63 09 61 62 11 01 10 05



Ring Binder made of one piece solid board, PVC covered, glued and welded. In folio and A4 size. Spine area equipped with pocket and label.

Ring Binder yang terbuat dari selembar karton yang solid dan dilapisi PVC. Dilengkapi dengan kantong label punggung.

A4 & Folio Ring Binders

Ring Binder A4

Ref	Description	Unit Price (Rp)	Avail. Packing
8215	1321 A4 2 O - 20 mm (3/4")	27.720,-	1/30
8212	1221 A4 2 D - 20 mm	28.820,-	1/20
8225	1322 A4 2 O - 25 mm (1")	28.710,-	1/20
8222	1222 A4 2 D - 25 mm	28.930,-	1/20
8322	1232 A4 3 D - 25 mm	34.320,-	1/20
8422	1242 A4 4 D - 25 mm	35.860,-	1/20
8242	1224 A4 2 D - 40 mm (1 1/2")	33.440,-	1/15
8342	1234 A4 3 D - 40 mm	39.710,-	1/15
8442	1244 A4 4 D - 40 mm	42.680,-	1/15
8252	1225 A4 2 D - 52 mm (2")	40.810,-	1/15
8352	1235 A4 3 D - 52 mm	53.900,-	1/15
8452	1245 A4 4 D - 52 mm	54.890,-	1/15
8262	1226 A4 2 D - 65 mm (2 1/2")	46.090,-	1/12
8362	1236 A4 3 D - 65 mm	59.950,-	1/12

Ring Binder Folio

Ref	Description	Unit Price (Rp)	Avail. Packing
8216	1321 Folio 2 O - 20 mm (3/4")	31.570,-	1/30
8213	1221 Folio 2 D - 20 mm	32.780,-	1/20
8226	1322 Folio 2 O - 25 mm (1")	32.560,-	1/20
8223	1222 Folio 2 D - 25 mm	32.890,-	1/20
8243	1224 Folio 2 D - 40 mm (1 1/2")	36.300,-	1/15
8253	1225 Folio 2 D - 52 mm (2")	43.230,-	1/15
8263	1226 Folio 2 D - 65 mm (2 1/2")	50.820,-	1/12

Compressor

Ref	Description	Unit Price (Rp)	Avail. Packing
8849-02	Clix 80 (for 2 ring)	880,-	1
8849-03	Jumbo Clix (for 3 ring)	5.060,-	1

Compressor

Made of plastic, with centimeters. Compress your document on your 2 and 3 ring binder.

Kompresor dengan centimeter, terbuat dari plastik dan dipergunakan pada binder dengan 2 atau 3 ring.

Colours:

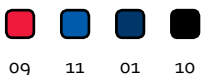

19 other colours available on request

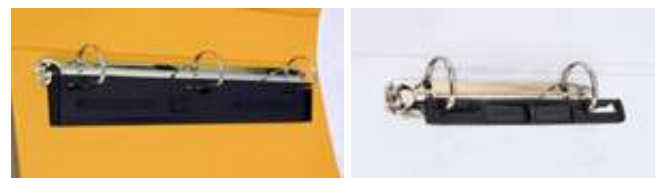

Jumbo Clix (Ref. 8849-03)

Clix 80 (Ref. 8849-02)





A2 & A3 Ring Binders

Ring Binder A2 & A3

One Piece Glued Binder in A2 and A3 size. For A2 in oblong (landscape) and A3 in upright (portrait) or oblong (landscape) fitted with D-Ring 52 or 65 mm capacity.

Binder yang dibentuk dari selembur karton yang dilapisi PVC dalam ukuran A2 dan A3. Untuk ukuran A2 tersedia bentuk landscape (memanjang), sedangkan untuk A3 tersedia bentuk landscape (memanjang) dan portrait (berdiri), dilengkapi D-ring mekanik dengan kapasitas 52 atau 65 mm.

Colours:  
01 10

Ring Binder A2 & A3 - Landscape

Ref	Description	Unit Price (Rp)	Available Packing
8052	1468 A3 / 2 D - 52 mm (2")	51.480,-	1/9
8053	1468 A3 / 3 D - 52 mm	63.250,-	1/9
8054	1468 A3 / 4 D - 52 mm	64.130,-	1/9
8062	1468 A3 / 2 D - 65 mm (2 1/2")	54.890,-	1/9
8063	1468 A3 / 3 D - 65 mm	67.320,-	1/9

Ring Binder A2 & A3 - Potrait

Ref	Description	Unit Price (Rp)	Available Packing
8152	1467 A3 / 2 D - 52 mm (2")	55.880,-	1/12
8153	1467 A3 / 3 D - 52 mm	67.650,-	1/12
8154	1467 A3 / 4 D - 52 mm	68.640,-	1/12
8162	1467 A3 / 2 D - 65 mm (2 1/2")	59.400,-	1/12
8163	1467 A3 / 3 D - 65 mm	71.830,-	1/12
1265 10	A2 / 2 x 4D - 35 mm	162.580,-	1



Laminated Ring Binders

Laminated Ring Binder

Ref	Description	Unit Price (Rp)	Available Packing
1130	A4 - 2O - 25mm	29.590,-	1/20
1132	Folio - 2O - 25mm	29.810,-	1/20

Laminated Ring Binder

Ring Binder with glossy paper cover in attractive colours. Fitted with 2 O - 25mm ring or Clip with Lever Clip mechanism.

Ring Binder berlapis kertas gloss dengan warna menarik. Mekanik ring 2 O - 25 mm atau Clip dan Lever Clip.

Colours: 
10 15 06 09 11

Punchless Binder

Ref	Description	Unit Price (Rp)	Available Packing
3301	Punchless Binder / A4 / col:01,04, 09, 10, 11	31.900,-	1/20
3302	Punchless Binder / Folio / col:01, 04, 09, 10	35.970,-	1/20

Punchless Binder

PVC glued binder with heavy duty mechanism. Holding up to 100 unpunched sheets. Files document with clamping mechanism. No need to punch holes.

Binder PVC dengan mekanik lever clip model klem untuk kertas tanpa lubang, dengan kapasitas setebal 100 lembar. Anda dapat mem-bundle dokumen tanpa harus menggunakan perforator/ melubanginya terlebih dahulu.

Colours: 
06 09 11 01 04 10



Clamped



Open



2 Rings



3 Rings



4 Rings



Insert Ring Binders

Insert Ring Binders

Ring Binder with clear pocket on the front and spine for insertion of printed material etc. Size of insert up to 250 x 307 mm for A4 and 250x337mm for Folio. Highly recommended for use in seminars and your personal file.

Insert Ring Binder dengan plastik / kantong bening yang tidak mudah mengkerut pada bagian cover depan dan punggung agar dapat mengganti isi cover sesuai keinginan. Ukuran kantong hingga 250x307mm untuk A4 dan 250 x 337mm untuk Folio. Cocok pada saat acara seminar dan pemakaian pribadi.

Insert Ring Binder A5 Size

Ref	Description (Size / Mechanism / Capacity)	Unit Price (Rp)	Avail. Packing
8521	5222 A5 / 2 D / 25 mm (1")	23.100,-	1/25

Insert Ring Binder Folio (F) Size

Ref	Description (Size / Mechanism / Capacity)	Unit Price (Rp)	Avail. Packing
8523	5222 F / 2 D / 25 mm (1")	38.830,-	1/20
8543	5224 F / 2 D / 40 mm (1 1/2")	42.130,-	1/15
8553	5225 F / 2 D / 52 mm (2")	49.830,-	1/15
8563	5226 F / 2 D / 65 mm (2 1/2")	57.530,-	1/12

Insert Ring Binder A4 Size

Ref	Description (Size / Mechanism / Capacity)	Unit Price (Rp)	Avail. Packing
8605	5330 A4 / 3 O / 16 mm	34.210,-	1/20
8515	5321 A4 / 2 O / 20 mm	33.220,-	1/20
8512	5221 A4 / 2 D / 20 mm	34.320,-	1/20
8522	5222 A4 / 2 D / 25 mm (1")	34.430,-	1/20
8622	5232 A4 / 3 D / 25 mm	39.820,-	1/20
8722	5242 A4 / 4 D / 25 mm	41.360,-	1/20
8542	5224 A4 / 2 D / 40 mm (1 1/2")	38.720,-	1/15
8642	5234 A4 / 3 D / 40 mm	45.100,-	1/15
8742	5221 A4 / 4 D / 40 mm	47.960,-	1/15
8552	5225 A4 / 2 D / 52 mm (2")	46.420,-	1/15
8652	5235 A4 / 3 D / 52 mm	59.620,-	1/15
8752	5245 A4 / 4 D / 52 mm	60.610,-	1/15
8562	5226 A4 / 2 D / 65 mm (2 1/2")	51.810,-	1/12
8662	5236 A4 / 3 D / 65 mm	65.560,-	1/12
8762	5246 A4 / 4 D / 65 mm	72.160,-	1/12

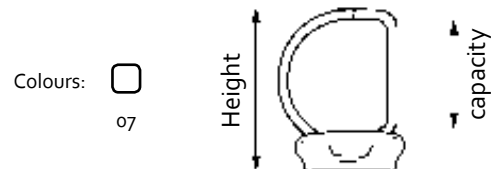

Post / Pipe Binder			
Ref	Description	Unit Price (Rp)	Available Packing
1361	A4 size - 6 cm capacity	70.950,-	1/15
1391	A4 size - 8 cm capacity	79.750,-	1/15
1311	A4 size - 10 cm capacity	103.180,-	1/15
1362	Folio size - 6 cm capacity	71.940,-	1/15
1392	Folio size - 8 cm capacity	81.730,-	1/15
1312	Folio size - 10 cm capacity	105.600,-	1/15

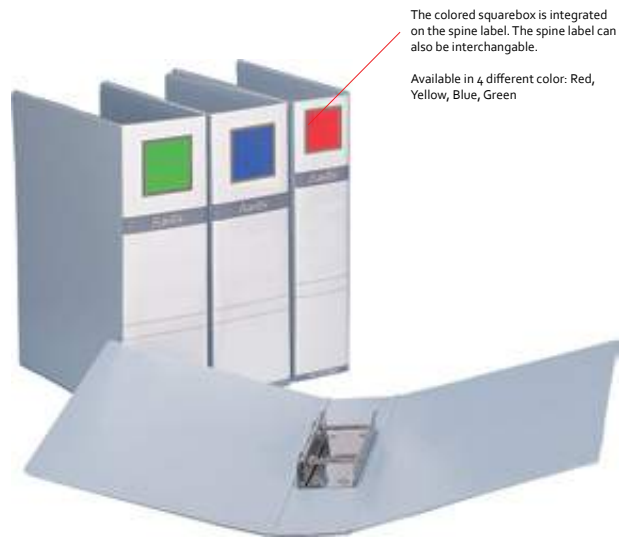

The colored squarebox is integrated on the spine label. The spine label can also be interchangeable.

Available in 4 different color: Red, Yellow, Blue, Green



Colours: 01 05

Pipe Binders / Post Binders

Binder with spine, mounted with special pipe type mechanism and locking system. Whole length spine pocket with 4 times reusable spine label. Pipe distance 80 mm, capacity 60mm, 80 mm and 100 mm.

Binder dengan mekanik untuk jenis pipa dan sistem pengunci terpasang pada punggung. Kantong panjang pada punggung dilengkapi dengan 2 label yang dapat dipakai bolak-balik. Jarak lubang 80 mm dan kapasitas 60 mm, 80 mm dan 100mm.

Insert Post / Pipe Binder			
Ref	Description	Unit Price (Rp)	Available Packing
1361l07	A4 - 6 cm capacity	75.240,-	1/15
1391l07	A4 - 8 cm capacity	84.810,-	1/15
1311l07	A4 - 10 cm capacity	115.500,-	1/15

Insert Post / Pipe Binder

Binder with spine, mounted with special pipe type mechanism and locking system. Pipe type Biznder with clear pocket on the front.

Binder dengan mekanik untuk jenis pipa dan sistem pengunci terpasang pada punggung. Binder jenis pipa ini dilengkapi kantong bening pada bagian depan dan punggung.

Colours: 07



The printed design on this insert cover shown is not a part of the standard product, this is an illustration that you can fill the pocket cover with your own printing material.

Computer Files

For unburst print-outs. Strong rigid cover with multipunching to take various widths. Suitable for vertical or suspension filing. Thanks to the strong construction, Bantex computer files can be stored vertically like lever arch files and ring binders. All Computer Files equipped with Computer Label Tab suitable for vertical or suspension filing. This tab makes instant reading of filing contents.

Khusus untuk print-out bersambung dengan mekanik berlubang banyak (kertas continuous form). Sesuai untuk kertas komputer dengan berbagai ukuran. Dilengkapi dengan Computer Tab sebagai identifikasi isi file. Cocok digunakan pada bagian keuangan, Accounting dan Bank.



Colours: ■ 09 ■ 01 ■ 11 ■ 10



Computer File			
Ref	Description	Unit Price (Rp)	Available Packing
1562	Computer File 14 7/8x11"	56.320,-	1/12
1564	Computer File 9 1/2x11"	44.000,-	1/30

Computer Tab

Tabbing for 1562 & 1564. This tab is applied together with the Bantex Computer File. It makes as easy recognition of the file content, either for filing on Trolley or in Shelves.

Tab untuk Computer File ref no. 1562 dan 1564. Tab ini disediakan bersama Computer File Bantex untuk memudahkan mengidentifikasi / pengenalan isi file, baik yang disimpan pada Trolley maupun pada rak.

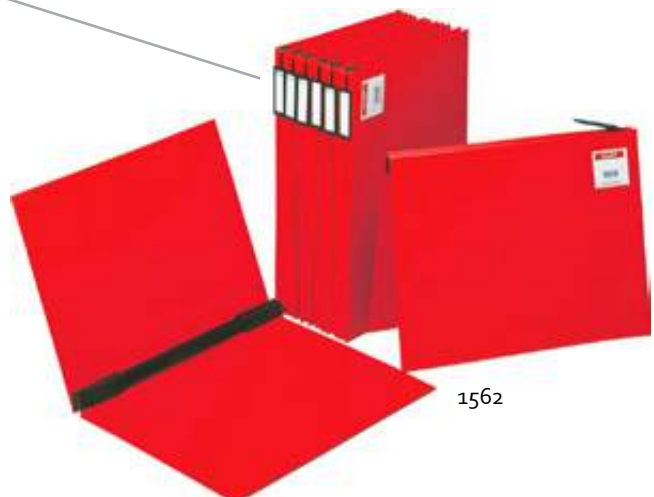

Data Binder / Computer Binder - 22 Poles

Ref	Description	Unit Price (Rp)	Available Packing
1542	14 7/8 x 11" - 35 mm	71.390,-	1/20
1544	9 1/2 x 11" - 35 mm	63.250,-	1/20

Data Binder / Computer Binder - 22 Poles

For burst print-outs. Mechanism with 22 poles and 35 mm capacity. Designed for vertical filing.

Untuk menyimpan print-out continous form. Mekanik dengan 22 lubang dan kapasitas 35 mm.

Colours: ■ ■ ■ ■
09 11 01 10



1542

Computer/Data Ring Binder

Ref	Description	Unit Price (Rp)	Available Packing
1593	9 1/2 x 11" 4B - 35 mm	36.630,-	1/20*
1594	14 7/8 x 11" 4B - 35 mm	41.250,-	1/20*
1595	9 1/2 x 11" 4B - 52 mm	38.280,-	1/15*
1596	14 7/8 x 11" 4B - 52 mm	42.790,-	1/15*

Computer/Data Ring Binder

For burst print-outs. Mechanism suitable for most print-out sizes. With spine label and metal finger ring. With 35mm & 52mm capacity.

Untuk menyimpan hasil print-out continous form. Bisa dipakai hampir semua jenis computer print-out. Dilengkapi label punggung dan finger ring. Tersedia dengan kapasitas 35 mm dan 52mm.

Colours: ■ ■ ■ ■
09 11 01 10



Trolley for Computer/Suspension File

Ref	Description	Unit Price (Rp)	Available Packing
1660	64 x 69 x 30 - 46 cm	536.250,-	1

Trolley for Computer/Suspension File

Solid, lacquered metal. Suitable & adjustable for Suspension File 3460 or 3470 (page 78). Also for 1562 & 1564 series (page 26). Could be placed easily around your office.

Troli dengan konstruksi yang di vernish / dilapisi metal. Kuat, fleksibel dan mudah dipindah tempatkan. Dapat digunakan untuk semua jenis suspension file (halaman 78) dan seri 1562 serta 1564 (halaman 26) and 5 cm. A5/Receipts with Lever Arch Mechanism.





Banded Ring Binder A4-3Ring (A126)

Ref	Description	Unit Price (Rp)	Available Packing
A126	Notes A4 TO 8026+8322+6045	66.770,-	1/14

Banded Ring Binder A4-3Ring (A126)

A product bundled consist of Ring Binder A4 3 Ring D type - 25 mm (8322), Cardboard Divider A4 size - 5 pages (6045), Block note A4 Top Opening 7 Holes HVS 70 gr 50 sheets (8026).

Paket produk yang terdiri dari Ring Binder A4 3 Ring D type - 25 mm (8322), Cardboard Divider A4 size - 5 pages (6045), Block note A4 Top Opening 7 Holes HVS 70 gr 50 sheets (8026).



Banded Ring Binder A4-4Ring (A135)

Ref	Description	Unit Price (Rp)	Available Packing
A135	Notes A4 SO 8025+8422+6045	67.210,-	1/14

Banded Ring Binder A4-4Ring (A135)

A product bundled consist of Ring Binder A4 4 Ring D type - 25 mm (8422), Cardboard Divider A4 size - 5 pages (6045), Block note A4 Side Opening 7 Holes HVS 70 gr 50 sheets (8025).

Paket produk yang terdiri dari Ring Binder A4 4 Ring D type - 25 mm (8422), Cardboard Divider A4 size - 5 pages (6045), Block note A4 Side Opening 7 Holes HVS 70 gr 50 sheets (8025).



Banded Ring Binder A5-2Ring (A128)

Ref	Description	Unit Price (Rp)	Available Packing
A128	Notes A5 TO 8028+8221+8610	35.970,-	1/14

Banded Ring Binder A5-2Ring (A128)

A product bundled consist of Ring Binder A5 2 Ring D type - 25 mm (8221), Cardboard Divider A5 size - 5 pages (8610), Block note A5 Top Opening 2 Holes HVS 70 gr 50 sheets (8028).

Paket produk yang terdiri dari Ring Binder A5 2 Ring D type - 25 mm (8221), Cardboard Divider A5 size - 5 pages (8610), Block note A5 Top Opening 2 Holes HVS 70 gr 50 sheets (8028).



Banded Ring Binder A5-2Ring (A127)

Ref	Description	Unit Price (Rp)	Available Packing
A127	Notes A5 SO 8027+8221+8610	35.970,-	1/14

Banded Ring Binder A5-2Ring (A127)

A product bundled consist of Ring Binder A5 2 Ring D type - 25 mm (8221), Cardboard Divider A5 size - 5 pages (8610), Block note A5 Side Opening 2 Holes HVS 70 gr 50 sheets (8027).

Paket produk yang terdiri dari Ring Binder A5 2 Ring D type - 25 mm (8221), Cardboard Divider A5 size - 5 pages (8610), Block note A5 Side Opening 2 Holes HVS 70 gr 50 sheets (8028).

Banded Insert Ring Binder A5 (A141 07)

Ref	Description	Unit Price (Rp)	Available Packing
A141	Loose Leaf A5 2 Holes 8031+8521+8610	36.520,-	1/14

Banded Insert Ring Binder A5 (A141 07)

A product bundled consist of Insert Ring Binder A5 2 Ring D type - 25 mm (8521), Cardboard Divider A5 size - 5 pages (8610), Loose Leaf A5 2 Holes HVS 70 gr 50 sheets (8031).

Paket produk yang terdiri dari Insert Ring Binder A5 2 Ring D type - 25 mm (8521), Cardboard Divider A5 size - 5 pages (8610), Loose Leaf A5 2 Holes HVS 70 gr 50 sheets (8031).



Banded Insert Ring Binder A4 (A142 07)

Ref	Description	Unit Price (Rp)	Available Packing
A142	Loose Leaf A4 7 Holes 8030+8622+6045	69.630,-	1/14

Banded Insert Ring Binder A4 (A142 07)

A product bundled consist of Insert Ring Binder A4 3 Ring D type - 25 mm (8622), Cardboard Divider A4 size - 5 pages (6045), Loose Leaf A4 7 Holes HVS 70 gr 50 sheets (8030).

Paket produk yang terdiri dari Insert Ring Binder A4 3 Ring D type - 25 mm (8622), Cardboard Divider A4 size - 5 pages (6045), Loose Leaf A4 7 Holes HVS 70 gr 50 sheets (8030).



Banded Insert Ring Binder A4 (A143 07)

Ref	Description	Unit Price (Rp)	Available Packing
A143	Loose Leaf A4 7 Holes 8030+8722+6045	70.620,-	1/14

Banded Insert Ring Binder A4 (A142 07)

A product bundled consist of Insert Ring Binder A4 4 Ring D type - 25 mm (8722), Cardboard Divider A4 size - 5 pages (6045), Loose Leaf A4 7 Holes HVS 70 gr 50 sheets (8030).

Paket produk yang terdiri dari Insert Ring Binder A4 4 Ring D type - 25 mm (8722), Cardboard Divider A4 size - 5 pages (6045), Loose Leaf A4 7 Holes HVS 70 gr 50 sheets (8030).





8540



8070

Insert CD Binder

CD binder with mechanism 2D 40mm. Available in fruit colours of grape, blueberry, melon, mango, and lime. Included 5 pockets.

CD binder dengan memakai mekanik 2D 40mm. Tersedia dalam warna yang cerah/modern seperti, grape, blueberry, melon, mango, dan lime. Termasuk 5 buah kantong CD.



Insert DVD Binder

DVD binder with clear pocket on the front and spine for insertion of printed title or DVD movie cover. Available in fruit colours of grape, blueberry, melon, mango, and lime. Capacity maximum to 20 DVDs.

DVD binder dengan kantong bening pada bagian cover depan dan punggung agar dapat di-isi cover judul film. Tersedia dalam warna yang modern seperti, grape, blueberry, melon, mango, dan lime.

Insert CD Binder

Ref	Description	Unit Price (Rp)	Avail. Pack
8540	CD Binder 2 D / capacity: 40 mm / including 5 pcs pocket 8070	29.920,-	1 / 12
8070	CD Pocket for 8540 (10 pcs / bag)	14.300,-	1 bag *

Insert DVD Binder

Ref	Description	Unit Price (Rp)	Avail. Pack
8541	DVD Binder 2 D / capacity: 40 mm / including 5 pcs pocket 8071	43.120,-	1 / 10
8071	DVD Pocket for 8541 (10 pcs / bag)	25.300,-	1 bag *



8541

8071



PP Multiring Binder			
Ref	Description	Unit Price (Rp)	Avail. Pack
1334 23	A5/ 20 Ring O - 25mm/ Sky Blue	49.500,-	1/20
1334 45	A5/ 20 Ring O - 25mm/ Peach	49.500,-	1/20
1334 72	A5/ 20 Ring O - 25mm/ Pistachio	49.500,-	1/20
1334 74	A5/ 20 Ring O - 25mm/ Musky Pink	49.500,-	1/20
1334 76	A5/ 20 Ring O - 25mm/ Cool Aqua	49.500,-	1/20
1336 23	B5 / 26 Ring O - 25mm/ Sky Blue	66.000,-	1/20
1336 45	B5 / 26 Ring O - 25mm/ Peach	66.000,-	1/20
1336 72	B5 / 26 Ring O - 25mm/ Pistachio	66.000,-	1/20
1336 74	B5 / 26 Ring O - 25mm/ Musky Pink	66.000,-	1/20
1336 76	B5 / 26 Ring O - 25mm/ Cool Aqua	66.000,-	1/20

Multiring Binder PP - A5 & B5

Batik Edition Bantex multiring binder is made from Polypropylene eco-friendly material on the outer side and modern batik theme inner lining. Available in 5 pastel color options with strong metal rings with 25 mm capacity. 5 color divider Polypropylene material & premium 80 gsm loose leaf writing paper are included in this product.

Bantex Multi Ring Binder Edisi Batik terbuat dari bahan Polypropylene (PP) yang ramah lingkungan pada cover luar dan lining bertema batik modern di bagian dalam. Hadir dalam 5 pilihan warna pastel menggunakan ring berbahan metal yang kuat berkapasitas 25 mm. Dilengkapi dengan divider bahan Polypropylene 5 warna, dan kertas tulis Bantex Loose Leaf paper 80 gsm.

Colours:
 23 76 72 45 74





Exclusive Multiring Binder

Exclusive Multiring Binder			
Ref	Description	Unit Price (Rp)	Available Packing
1325	A5 / 20 Ring O - 25mm	59.400,-	1/20
1327	B5 / 26 Ring O - 25mm	75.350,-	1/20

Bantex exclusive multiring binder come in two size options (A5 & B5) and 5 exclusive color options, using strong metal ring with 25 mm paper capacity. 5 color cardboard dividers & Bantex 80 gsm Loose Leaf writing paper included.

Bantex exclusive multiring binder hadir dalam 2 pilihan ukuran (A5 & B5) dan 5 pilihan warna eksklusif, menggunakan ring berbahan metal yang kuat berkapasitas 25 mm. Dilengkapi divider karton 5 warna & kertas tulis Bantex Loose Leaf paper 80gsm.

Colours: 
09 12 06 04 01





A5 & B5 Multi Ring Binder

Bantex Multiring Loose Leaf Binder come in two size (A5 & B5) and 16 exclusive color options using strong metal ring with 25 mm paper capacity. Equipped with plastic pocket in both inner side cover, 5 color cardboard dividers, and Bantex 80 gsm Loose Leaf writing paper. The A5 size binders use 20 metal ring, and the B5 size binders use 26 metal rings.

**A5 & B5
Multiring Binder**

Multi Ring Binder A5 & B5			
Ref	Description	Unit Price (Rp)	Available Packing
1324	A5 / 20 Ring O - 25mm	55.990,-	1/20
1326	B5 / 26 Ring O - 25mm	63.030,-	1/20

Multi Ring Binder A5 & B5

Bantex Multiring Loose Leaf Binder hadir dalam 16 pilihan warna eksklusif dan menggunakan ring berbahan metal yang kuat berkapasitas 25 mm untuk kertas Loose Leaf A5/B5. Dilengkapi dengan pocket plastik pada bagian dalam cover depan dan belakang, divider cardboard 5 warna, dan kertas tulis Bantex Loose Leaf paper dengan ketebalan istimewa 80 gsm. Binder A5 menggunakan 20 ring, binder B5 menggunakan 26 ring.

Colours:





Dividers For Multiring Binder

Plastic index tabs dividers for multiring binder available in A5 & B5 size. The B5 size comes with 2 index options 1-5 index & 1-10 index. The A5 available with 1-5 index.

Divider dengan index tab plastik untuk multiring binder tersedia dalam ukuran A5 & B5. Ukuran B5 memiliki 2 pilihan index 1-5 & 1-10. Ukuran A5 tersedia dengan index 1-5.



Dividers for Multiring Binder			
Ref	Description	Unit Price (Rp)	Available Packing
8607	B5 - Tabs Index 1-5	8.470,-	1/30 Set
8608	B5 - Tabs Index 1-10	14.300,-	1/20 Set
8611	A5 Size / 5 pages (1-5 index) / 20 holes	7.260,-	1/25 Set



8607



8608



8609 13 (Galaxy Space)



8609 14 (Enigma Blitz)



8609 15 (Night Blue)



8609 16 (Luminance Royal)



8609 17 (Bouldering Wall)

Dividers for Multiring Binder B5

Ref	Description	Unit Price (Rp)	Available Packing
8609 13	B5 6 Dividers Galaxy Space	10.560,-	1/25 set
8609 14	B5 6 Dividers Enigma Blitz	10.560,-	1/25 set
8609 15	B5 6 Dividers Night Blue	10.560,-	1/25 set
8609 16	B5 6 Dividers Luminance Royal	10.560,-	1/25 set
8609 17	B5 6 Dividers Bouldering Wall	10.560,-	1/25 set
8609 18	B5 6 Dividers Trenchant Shade	10.560,-	1/25 set



8609 18 (Trenchant Shade)

Pockets for Multiring Binder

Ref	Description	Unit Price (Rp)	Available Packing
8002-08	A5 - PP Pockets (10 sheets)	8.800,-	1 /10 Set
8001	B5 - PP Pockets (10 sheets)	9.900,-	1 /10 Set

Pockets for Multiring Binder

Storage pockets made from eco-friendly polypropylene material, suitable for additional storage in multiring/ loose leaf binder A5 / B5.

Kantong penyimpanan yang terbuat dari material polypropylene ramah lingkungan. Berfungsi sebagai media penyimpanan tambahan pada multiring binder/ loose leaf binder ukuran A5 / B5.



Dividers For Multiring Binder

Fancy themed B5 multiring dividers

Fancy themed B5 multiring dividers available in 6 designs. Contains 6 divider with plain colored plastic tabs + 1 cover page.

Divider multiring B5 bertema fancy tersedia dalam 6 pilihan desain. berisi 6 halaman divider dengan tabs plastik polos 6 warna + 1 halaman cover.

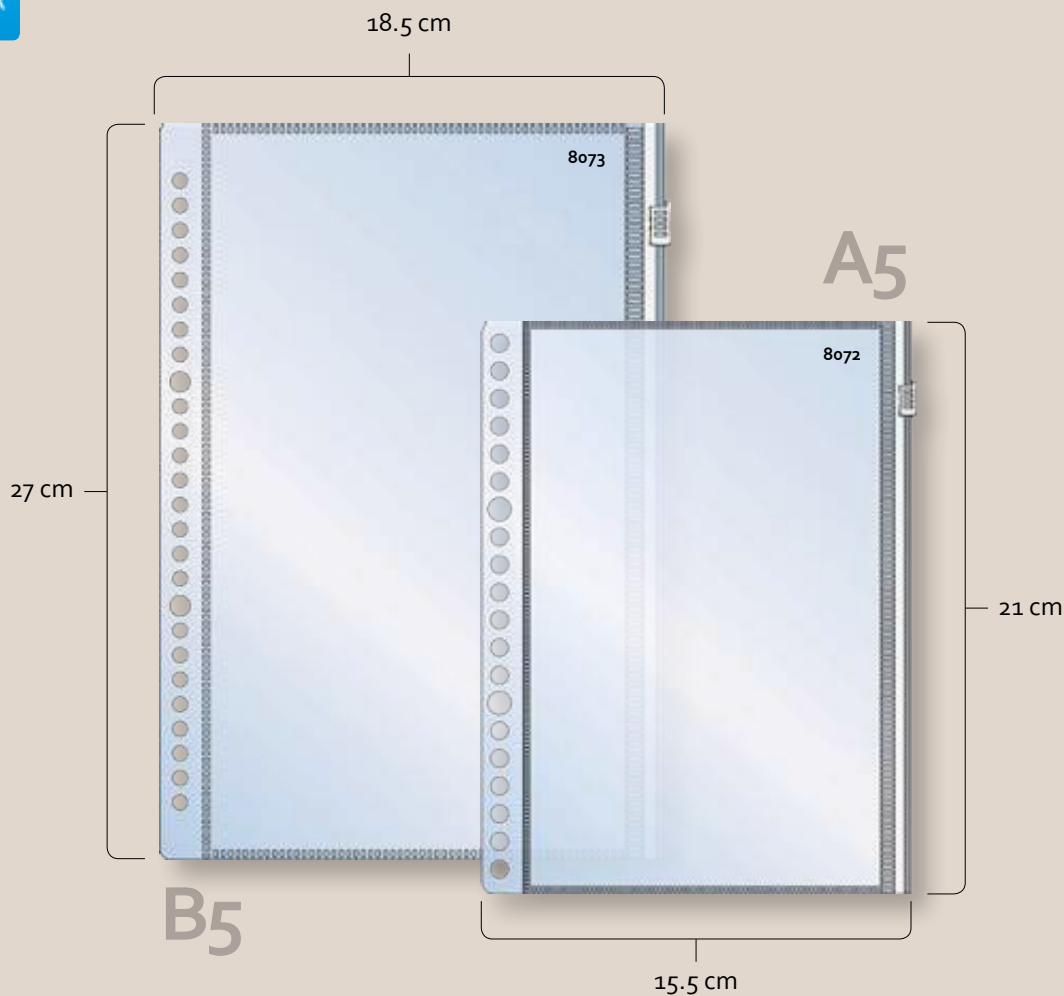

Multiholes Zip Pocket

Ref	Description	Unit Price (Rp)	Available Packing
8072 08	A5 size / PP material	8.140,-	1/50/600
8073 08	B5 size / PP material	9.900,-	1/50/600



Multiholes Zip Pockets

Additional pocket with zip lock for multiring binder. Made of non reactive & eco-friendly PP material in A5 and B5 size. Provide extra storage for your files, stationery, and personal stuff.

Kantong tambahan untuk ditempatkan di multiring binder dengan zip lock plastik berbahan PP yang ramah lingkungan. Tersedia dalam ukuran A5 dan B5. Dapat digunakan untuk menyimpan berkas, stationery, ataupun barang-barang pribadi. Anti lengket & aman untuk berkas hasil fotocopy.





A5 & B5 Loose Leaf Paper for Multiring Binder

Ref	Description	Unit Price (Rp)	Available Packing
8601 00	A5 size / HVS 80gsm / 50 Sheets / 20 Holes / 6mm ruled 30 Lines	10.670,-	1/240
8600 00	B5 size / HVS 80gsm / 50 Sheets / 26 Holes / 7mm ruled 30 Lines	16.280,-	1/106

Loose Leaf Paper A5 & B5

Loose Leaf Paper A5 & B5

Refill writing paper for 20 rings - multiring binder (A5) and 26 rings - multiring binder (B5). Suitable for writing notes or exercises, commonly used by students. 80 gsm paper thickness gives you extra comfort in reading the writings.

Kertas tulis bergaris isi ulang untuk multiring binder 20 ring (A5) dan 26 ring (B5). Cocok untuk digunakan sebagai media catatan, umum digunakan pelajar & mahasiswa. Ketebalan kertas istimewa 80 gsm memberi kenyamanan lebih untuk visibilitas tulisan anda.



8600 00



8601 00

80 gsm

Paper thickness



A5 Loose Leaf Paper for Binder

Ref	Description	Unit Price (Rp)	Available Packing
8031	A5 Loose Leaf paper, 2 Holes, HVS 70 gsm, 50 sheets	12.100,-	1/100

A5 Loose Leaf Paper for Binder

Ruled Loose Leaf paper in A5 size, with 2 Holes, HVS 70 gsm, product contains 50 sheets of paper. Suitable for A5 Binder with 2 rings.

Kertas Loose Leaf bergaris ukuran A5, dengan 2 lubang, HVS 70 gsm, berisi 50 lembar kertas. Dapat digunakan pada binder A5 dengan 2 ring.



A4 Loose Leaf Paper for Binder

Ref	Description	Unit Price (Rp)	Available Packing
8030	A4 Loose Leaf paper, 7 Holes, HVS 70 gsm, 50 sheets	26.290,-	1/100

A4 Loose Leaf Paper for Binder

Ruled Loose Leaf paper in A4 size, with 7 Holes, HVS 70 gsm, product contains 50 sheets of paper. Suitable for folio & A4 Binder with 2, 3, and 4 rings.

Kertas Loose Leaf bergaris ukuran A4, dengan 7 lubang, HVS 70 gsm, berisi 50 lembar kertas. Dapat digunakan pada binder folio & A4 dengan 2, 3, dan 4 ring.



Block Notes A4 Side Opening

Ref	Description	Unit Price (Rp)	Available Packing
8025 00	A4 size, Side Opening, 7Holes, HVS 70gsm, 50 sheets	28.710,-	1/100

Block Notes A4 Side Opening

Ruled block note A4 Side Opening 7 Hole HVS 70 gsm 50 sheets. Suitable for folio & A4 Binder with 2, 3, and 4 rings.

Block note A4 bergaris buka samping, 7 lubang HVS 70 gsm 50 lembar. Dapat digunakan pada binder folio & A4 dengan 2, 3, dan 4 ring.

Block Notes A4 Top Opening

Ref	Description	Unit Price (Rp)	Available Packing
8026 00	A4 size, Top Opening, 7Holes, HVS 70 gsm, 50 sheets	28.930,-	1/100

Block Notes A4 Top Opening

Ruled block note A4 Top Opening 7 Hole HVS 70 gsm 50 sheets. Suitable for folio & A4 Binder with 2, 3, and 4 rings.

Block note A4 bergaris buka atas, 7 lubang HVS 70 gsm 50 lembar. Dapat digunakan pada binder folio & A4 dengan 2, 3, dan 4 ring.



Block Notes A5 Side Opening

Ref	Description	Unit Price (Rp)	Available Packing
8027 00	A5 size, Side Opening, 2Holes, HVS 70 gsm, 50 sheets	13.970,-	1/180

Block Notes A5 Side Opening

Ruled block note A5 Side Opening 2 Hole HVS 70 gsm 50 sheets. Suitable for A5 Binder with 2 rings.

Block note A5 bergaris buka samping, 2 lubang HVS 70 gsm 50 lembar. Dapat digunakan pada binder A5 dengan 2 ring.



Block Notes A5 Top Opening

Ref	Description	Unit Price (Rp)	Available Packing
8028 00	A5 size, Top Opening, 2Holes, HVS 70 gsm, 50 sheets	13.970,-	1/180

Block Notes A5 Top Opening

Ruled block note A5 Top Opening 2 Hole HVS 70 gsm 50 sheets. Suitable for A5 Binder with 2 rings.

Block note A5 bergaris buka atas, 2 lubang HVS 70 gsm 50 lembar. Dapat digunakan pada binder A5 dengan 2 ring.





Kopi Toebroek Clipboard & A5 Multiring Binder

Clipboard & Multiring Binder Dagadu Series

Size Comparisson



B5
Multiring

A5
Multiring

Clipboard

Dagadu Series Multiring Binder			
Ref	Description	Unit Price (Rp)	Avail Pack
1328 40	B5 / 26 Ring O - 25mm / Gatot Mbaca	70.070,-	1/20
1328 41	B5 / 26 Ring O - 25mm / Jog Wheels	70.070,-	1/20
1328 42	B5 / 26 Ring O - 25mm / Kopi Toebroek	70.070,-	1/20
1328 43	B5 / 26 Ring O - 25mm / Srogza	70.070,-	1/20
1329 40	A5 / 20 Ring O - 25mm / Gatot Mbaca	52.470,-	1/20
1329 41	A5 / 20 Ring O - 25mm / Jog Wheels	52.470,-	1/20
1329 42	A5 / 20 Ring O - 25mm / Kopi Toebroek	52.470,-	1/20
1329 43	A5 / 20 Ring O - 25mm / Srogza	52.470,-	1/20



80 Gsm
Loose Leaf
Paper

5 Tabs
Divider

Clipboard & Multiring Binder Dagadu Series



Clipboard 4209

Multi Ring Binder A5 & B5 Dagadu Series

Bantex A5 & B5 size Multiring Loose Leaf Binder Dagadu Series come in several design themes, using strong metal rings with 25 mm paper capacity. Equipped with 5 tabs index divider inside.

Bantex multiring binder edisi Dagadu hadir dalam 2 ukuran (A5 & B5) dengan beberapa pilihan tema desain. Menggunakan ring berbahan metal yang kuat berkapasitas 25 mm dan telah dilengkapi dengan index divider 5 tabs.

Clipboard Dagadu Series

Fancy writing board in several design themes. The board is covered & protected with smooth transparent layer to make it water resistant & last longer

Alas menulis dengan beberapa pilihan tema desain berbeda. Dilengkapi lapisan plastik transparan untuk memberikan perlindungan dan ketahanan ekstra.

Dagadu Series Clipboard

Ref	Description	Unit Price (Rp)	Avail. Pack
4209 40	Clipboard - Gatot Mbaca	14.300,-	1/24
4209 41	Clipboard - Jog Wheels	14.300,-	1/24
4209 42	Clipboard - Kopi Toebroek	14.300,-	1/24
4209 43	Clipboard - Srogza	14.300,-	1/24

Clipboard & Multiring Binder Jog Wheels



1328 41

1329 41

4209 41

Clipboard & Multiring Binder Srogza



1328 43

1329 43

4209 43

Clipboard & Multiring Binder Gatot Mbaca



1328 40

1329 40

4209 40

Clipboard & Multiring Binder Kopi Toebroek



1328 42

1329 42

4209 42



A5 Multiring Binder
Fancy Series - Water Me

Fancy Series Multiring Binder

Bantex Fancy Series multiring binder come in two size (A5 & B5) with 4 design options from Bantex design competition. Equipped with strong metal ring with 25 mm paper capacity, 5 tabs index dividers, and 80 gsm loose leaf paper.

Bantex multiring binder Fancy Series hadir dalam 2 ukuran (A5 & B5) dengan 4 pilihan tema desain hasil lomba. Menggunakan ring berbahan metal yang kuat berkapasitas 25 mm, dilengkapi dengan index divider 5 tabs dan kertas tulis Bantex Loose Leaf paper dengan ketebalan istimewa 80 gsm.

Fancy Series Multiring Binder			
Ref	Description	Unit Price (Rp)	Avail Pack
1328 44	B5 / 26 Ring O - 25mm / Treasure	73.150,-	1/20
1328 45	B5 / 26 Ring O - 25mm / Femme	73.150,-	1/20
1328 46	B5 / 26 Ring O - 25mm / Never Give Up	73.150,-	1/20
1328 47	B5 / 26 Ring O - 25mm / Water Me	73.150,-	1/20
1329 44	A5 / 20 Ring O - 25mm / Treasure	54.450,-	1/20
1329 45	A5 / 20 Ring O - 25mm / Femme	54.450,-	1/20
1329 46	A5 / 20 Ring O - 25mm / Never Give Up	54.450,-	1/20
1329 47	A5 / 20 Ring O - 25mm / Water Me	54.450,-	1/20



Femme



Never Give Up



Treasure



Jalak Putih - White
A5 & B5 Multiring Binder

In cooperation with Taman Safari Indonesia & KASI (Konservasi Alam Satwa Indonesia) in a conservation effort of endangered Black-Winged Myna species, Bantex present Jalak Putih Edition multiring binder. This product comes in two size (A5 & B5) with 4 design options from design competition. Equipped with strong metal ring with 25 mm paper capacity, 5 tabs index dividers, and 80 gsm loose leaf paper.

Jalak Putih Multiring Binder			
Ref	Description	Unit Price (Rp)	Avail. Pack
1328 37	B5 / 26 Ring O - 25mm / Green	76.450,-	1/20
1328 38	B5 / 26 Ring O - 25mm / White	76.450,-	1/20
1328 39	B5 / 26 Ring O - 25mm / Black	76.450,-	1/20
1329 37	A5 / 20 Ring O - 25mm / Green	55.990,-	1/20
1329 38	A5 / 20 Ring O - 25mm / White	55.990,-	1/20
1329 39	A5 / 20 Ring O - 25mm / Black	55.990,-	1/20

Jalak Putih Multiring Binder

Bekerja sama dengan Taman Safari Indonesia dan KASI (Konservasi Alam Satwa Indonesia) yang bertujuan untuk pelestarian dan konservasi burung Jalak Putih, Bantex menghadirkan multiring binder edisi Jalak Putih, dalam 2 ukuran (A5 & B5) dengan 3 pilihan tema desain. Menggunakan ring berbahan metal yang kuat berkapasitas 25 mm, dilengkapi dengan index divider 5 tabs dan kertas tulis Bantex Loose Leaf paper dengan ketebalan istimewa 80 gsm.



Green



Black



Bantex

Exclusive Fancy Clipboard



Exclusive Fancy Clipboard

Ref	Description	Unit Price (Rp)	Available Packing
8818	PP Material / CH size	32.120,-	1/24/144
8819	PP Material / FC size	56.760,-	1/12/72

Exclusive Fancy Clipboard

New exclusive design clipboard, made from high quality material in solid build quality, give an excellent feel & look to this product. Equipped with pen holder. Available in FC size & smaller CH size.

Clipboard dengan desain baru yang eksklusif. Material unggul dan kualitas pembuatan terbaik membuat produk ini terlihat & terasa istimewa. Dilengkapi dengan tempat pulpen di sisi kanan. Tersedia dalam ukuran FC & CH yang lebih kecil.

Colours:
 63 64 15 22 10



Clipboard			
Ref	Description	Unit Price (Rp)	Available Packing
4205	Folio size	16.500,-	1/20

Colours:  04 65 64 09 63 61 62 11 01 10 05



Clipboard

Clipboard

Special board with wire clip, hanger and rubber corner to ensure maximum hold on sheets.

Board (untuk alas menulis) dengan wire clip yang dilengkapi dengan gantungan dan penjepit berlapis karet agar dapat memegang kertas dengan baik.

Clipboard with Cover			
Ref	Description	Unit Price (Rp)	Available Packing
4211	Folio size / col: 01, 04, 05, 09, 10, 11, 61, 62, 63, 64, 65	28.930,-	1/15
4240	A4 Size / col: 01, 04, 05, 09, 10, 61, 62, 63, 64, 65	24.640,-	1/15

Clipboard with Cover

Clipboard with Cover

Clipboard with cover, inside pocket.

Clipboard yang dilengkapi dengan cover / penutup, kantong pada bagian dalam.



Colours:  04 65 64 09 63 61 62 11 01 10 05



Paket Ujian Ao84 (Folio Size)

Ref	Description	Unit Price (Rp)	Available Packing
Ao84	1 bh clipboard folio size (4205), 2 bh pensil Ujian Lyra 2B, 1 bh penghapus Lyra, 1 bh serutan Lyra, 1 bh penggaris UAN pelingkar jawaban	25.740,-	1/15

Clipboard Colours: 65 64 09 63 61 62 11 01 10



Paket Ujian A116

Ref	Description	Unit Price (Rp)	Available Packing
A116	1 bh hard clipboard 20x27cm (4207), 2 bh pensil Ujian Lyra 2B, 1 bh penghapus Lyra, 1 bh serutan Lyra, 1 bh penggaris UAN pelingkar jawaban	24.750,-	1/60 *

Clipboard Colours: 65 64 09 63 61 62 01 10



Paket Ujian A125

Ref	Description	Unit Price (Rp)	Available Packing
A125	1 bh hard clipboard A4 size (4208), 2 bh pensil Ujian Lyra 2B, 1 bh penghapus Lyra, 1 bh serutan Lyra, 1 bh penggaris UAN pelingkar jawaban	25.080,-	1/12 *

Clipboard Colours: 65 64 09 63 61 62 01 10

Paket Ujian Ao85 (Folio Size)

Ref	Description	Unit Price (Rp)	Available Packing
Ao85	1 bh hard clipboard folio size (8815) dengan sisi penggaris 30cm, 2 bh pensil Ujian Lyra 2B, 1 bh penghapus Lyra, 1 bh serutan Lyra, 1 bh penggaris UAN pelingkar jawaban	35.750,-	1/12

Clipboard Colours::



Clipboard Plastics

Ref	Description	Unit Price (Rp)	Available Packing
8815	Folio Size - Plastic Material	26.950,-	1/10

Clipboard Plastics

Made with strong plastic material. Complete with built in ruler (inch and cm).

Terbuat dari bahan plastik, kuat dan tidak mudah pecah. Dilengkapi penggaris dalam ukuran inch dan cm, dengan permukaan yang rapi dan solid.

Colours:





- Colours:
- 65 64 63 61 62 10

Clipboard A5			
Ref	Description	Unit Price (Rp)	Available Packing
4206	A5 Size	14.300,-	1/24

Clipboard A5

Compact size special clipboard with wire clip, hanger and rubber corner to ensure maximum hold on sheets.

Board (untuk alas menulis) berukuran ringkas dengan wire clip yang dilengkapi dengan gantungan dan penjepit berlapis karet agar dapat memegang kertas dengan baik.

Exclusive Clipboard

Exclusive Clipboard

Exclusive looking clipboard with cover, made from high quality eco-friendly material. Make your writing easy & look stylish anywhere. Equipped with pen holder.

Clipboard tulis berpenutup dengan penampilan eksklusif yang terbuat dari bahan ramah lingkungan berkualitas. Membuat aktivitas mencatat anda menjadi mudah & stylish. Dilengkapi dengan tempat pulpen.

- Colours:
- 10

Exclusive Clipboard			
Ref	Description	Unit Price (Rp)	Available Packing
8816 10	Folio Size	95.920,-	1/12/72



Desk Pad with Maps

Ref	Description	Unit Price (Rp)	Available Packing
4150	World map / 44 x 63 cm	35.640,-	1*
4151	Indonesia map / 44 x 63 cm	35.090,-	1*

Desk Pad with Maps

Scaled with clear overlay, blue back colour.

Alas meja dengan peta Indonesia atau dunia, permukaan dengan PVC bening dan dasar warna biru.

Colours: 
01 05



Desk Pad for Children

Ref	Description	Unit Price (Rp)	Available Packing
4160	Alphabets motives / 33 x 46 cm	25.080,-	1*
4162	Planets motives / 33 x 46 cm	19.360,-	1*

Desk Pad for Children

Children desk pads with Alphabets or picture of Planets, with measurements and international standard sizes.

Alas meja untuk anak-anak dengan desain alphabet atau susunan planet. Dilengkapi dengan ukuran-ukuran standar internasional.

Colours: 
01 05



Deskpad Calendar

Ref	Description	Unit Price (Rp)	Available Packing
4161	Deskpad Calendar Large	57.750,-	1
4163	Deskpad Calendar Small	33.000,-	1

Deskpad Calendar

Office Deskpad with square pattern to help you make monthly plan for your activity. Available in large size (2 colors: 01, 10) & small size (6 colors: 01, 10, 62, 63, 64, 65).

Office Desk Pad dengan pola persegi untuk membantu Anda membuat rencana bulanan untuk aktivitas Anda. Tersedia dalam ukuran large (2 warna: 01, 10) & small (6 warna: 01, 10, 62, 63, 64, 65).

Colours: 
10 01 62 63 64 65



4163

Size comparison with a pen

Exclusive Padfolio

Exclusive Padfolio

Exclusive looking foldable writing pad made from high quality eco-friendly material. Make your writing activity & creating notes easy & look stylish. Lined writing paper included on the package.

Alas menulis & mencatat berpenampilan eksklusif yang terbuat dari bahan ramah lingkungan berkualitas. Membuat aktivitas mencatat anda menjadi mudah & stylish. Kertas tulis bergaris sudah termasuk dalam paket item ini.

Exclusive Padfolio			
Ref	Description	Unit Price (Rp)	Available Packing
8817 10	Size: A4	87.120,-	1/12/48



1778

Turbo Mouse Pad			
Ref	Description	Unit Price (Rp)	Available Packing
1778	Turbo Mouse Pad / color: 01	62.150,-	1/200

Turbo Mouse Pad

Ultra thin ergonomic, non-skid mouse pad. Advance micro structured surface provides superior tracking & control.

Mouse pad ergonomis dengan permukaan yang dibuat bertekstur khusus untuk memberikan superioritas pengendalian mouse yang sangat baik.

Mouse Pad			
Ref	Description	Unit Price (Rp)	Available Packing
1788	Mouse Pad / color: 01, 05, 09, 10	37.950,-	1/10/200

Colours: 
05 10 01 09

1788



Mouse Pads

Mouse Pad

Mouse pad layered with soft fabric, made of foam board, size 220 x 255 mm, 6 mm thick.

Alas tetikus berlapis kain lembut dengan dasar busa padat berukuran 220 x 255 mm dan ketebalan 6 mm.

Wrist Support Gel Pad			
Ref	Description	Unit Price (Rp)	Available Packing
1729	Keyboard Wrist Support	376.090,-	1/20*



Soft squishy texture

Wrist Support Gel Pad

Wrist Support Gel Pad

Keyboard wrist support pad with gel inside. This products is covered with hard - wearing and durable Lycra. Provides unique support when typing.

Tatakan pergelangan tangan yang berisi bantalan gel. Sangat nyaman dipakai bekerja dengan komputer. Dibungkus bahan Lycra yang kuat namun lembut di kulit. Menghilangkan kelelahan ketika mengetik

Colours: 
10

Pocket With Top Opening

Made of document & photocopy safe (anti sticky surface), PP material in assorted thickness.

Terbuat dari bahan PP yang aman untuk menyimpan dokumen dan hasil fotokopi (tidak lengket). Tersedia dalam berbagai pilihan ketebalan.



Pocket With Top Opening (Retail Packing)

Made of document & photocopy safe (anti sticky surface), PP material in assorted thickness.

Terbuat dari bahan PP yang aman untuk menyimpan dokumen dan hasil fotokopi (tidak lengket). Tersedia dalam berbagai pilihan ketebalan.

Pocket With Top Opening

Ref	Description	Unit Price (Rp)	Available Packing
2035	A4 Size / Antiglare / 0.06mm thickness	1.430,-	1/100/1000
2035EW	A4 Size+0.5cm / 0.06mm thickness	1.540,-	1/100/1000
2040	A4 / clear / 0.06mm thickness	1.430,-	1/100/1000
2042	A4 Size / Antiglare / 0.09mm thickness	1.760,-	1/100/600
2044	Folio / Antiglare / 0.06mm thickness	1.760,-	1/100/500
2045	Folio / Antiglare / 0.09mm thickness	1.980,-	1/100/500
2046	A4 / clear / 0.08mm thickness	3.190,-	1/100/600
2051	A4 Size / clear / 0.12mm thickness	4.180,-	1/100/500
2021	10 x A4 in Bag / 0.05 mm thickness	9.900,-	10/500
2034	100 x A4 in Box / 0.05 mm thickness	99.000,-	10/100/1000
8843 08G	FC (Clear) / 0.06 mm thickness	1.760,-	1/100/1000

EW: Extra Wide

LS: Letter Size

Pocket With Top Opening (Retail Packing)

Ref	Description	Unit Price (Rp)	Avail. Packing
8032	20 x A5 2032 / 0.08mm thickness	26.400,-	1/5/30
8035	20 x A4 2035 / 0.06mm thickness	28.600,-	1/5/50
8040	20 x A4 2040 / clear / 0.06mm thickness	28.600,-	1/5/50
8042	20 x A4 2042 / 0.09mm thickness	35.200,-	1/5/30
8044	20 x FC 2044 / 0.06mm thickness	35.200,-	1/5/25
8045	20 x FC 2045 / 0.09mm thickness	39.600,-	1/5/25
8046	20 x A4 2046 / clear / 0.08mm thickness	63.800,-	1/5/30
8051	20 x A4 2051 / clear / 0.12mm thickness	83.600,-	1/30
8843	20 x FC (Clear) / 0,06 mm thickness	35.200,-	1/5/50
RB2035EW	20 x A4 2035EW / 0.06mm thickness	30.800,-	1/5/50

Pocket in A3 & A5 size with Top Opening

Ref	Description	Unit Price (Rp)	Available Packing
2032	A5 - 0,08 mm, AntiGlare	1.320,-	1/100/600
2036	A3 Portrait - 0,12 mm, AntiGlare	6.490,-	1/25/100/500
2037	A3 Landscape - 0,12 mm, AntiGlare	6.490,-	1/25/100/500
7423	2 x A4 - 0,12 mm, AntiGlare	15.180,-	1/10/100

Pocket in A3 & A5 Size With Top Opening

PP Pocket in A3 and A5. A3 in landscape or portrait. 7423 pocket for menu cover Ref. 7422.

Kantong PP dalam ukuran A3 dan A5. Untuk A3 tersedia dalam bentuk landscape (memanjang) atau portrait (berdiri). 7423 kantong khusus untuk dipakai bersama cover daftar makanan (menu) Ref. 7422.



Pocket in A2 size with Top Opening

Ref	Description	Unit Price (Rp)	Available Packing
2016	A2 Portrait/0,12mm/AntiGlare	41.140,-	1/10/100*
2017	A2 Landscape/0,12mm/AntiGlare	43.670,-	1/10/100*

Pocket in A2 Size With Top Opening

PP Pocket in A2 landscape or portrait. Copy safe, could store your maps, technicals drawing.

Kantong PP dalam ukuran A2 tersedia dalam bentuk landscape (memanjang) atau portrait (berdiri). Aman untuk hasil cetakan / print, dapat menyimpan peta, gambar dan hasil gambar teknik.

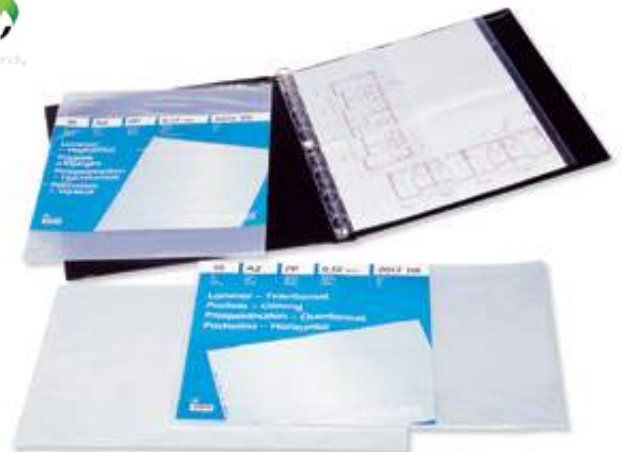

Folded A3 Pocket

Ref	Description	Unit Price (Rp)	Available Packing
2079	A3/A4 - 0,08 mm PP Anti-Glare	18.150,-	1/50/250

Folded A3 Pocket

Landscape folded A3 pocket for double A4. Store your maps, drawings and technical.

Kantong ukuran A3 Landscape (memanjang) yang dapat dilipat dan disimpan dalam ring binder A4. Dapat untuk menyimpan peta dan gambar.





Eco-Friendly

Side & Top Opening Pocket

Pocket With Side & Top Opening

With the opening at the top and inner side, this pocket allows you to store & retrieve document quickly & easily. The material is 0.09mm antiglare PP plastic give a nice touch feel & comfortable see-through reading.

Dengan bukaan pada sisi atas dan samping, kantung dokumen ini memberikan anda kemudahan untuk menyimpan dan mengambil dokumen dengan cepat. Material plastik transparan 0,09mm dengan fitur antiglare meminimalisir pantulan cahaya pada permukaannya, sehingga memberikan kenyamanan saat anda membaca dokumen di dalamnya.

Pocket With Side & Top Opening

Ref	Description	Unit Price (Rp)	Available Packing
2023	A4 Size / 0,09 mm - PP Anti-Glare	3.520,-	1/100/600



Expandable Pocket

Expandable Pocket

Pocket that can keep documents with maximum capacity 25 mm thickness. Made with environment - friendly material. Complete with flap and closure.

Kantong adjustable yang dapat menampung dokumen sampai ketebalan 25 mm. Dilengkapi tutup dengan tiga pengunci sesuai ketebalan dari dokumen tersebut.



Eco-Friendly

Expandable Pocket

Ref	Unit Price (Rp)	Available Packing
12013 08	15.510,-	1/20



Eco-Friendly

Pocket With Side Opening

Ref	Description	Unit Price (Rp)	Available Packing
2022	A4 Size / 0,08 mm - PP Anti-Glare	3.630,-	1/10/50

Pocket With Side Opening

Open at the Punched Edge.

Kantong PP dengan bukaan sisi kiri.

Document Pocket With Flap

Ref	Description	Unit Price (Rp)	Available Packing
2090	A4 - 10 Pcs / PP material	93.500,-	1/10/100

Document Pocket With Flap

A4 pocket, with flap opening to the right. Made of 0,13 mm durable PP.

Kantong ukuran A4, dilengkapi penutup di bagian sisi kanan. Terbuat dari bahan PP dengan ketebalan 0,13mm.



Zip Pocket

Ref	Description	Unit Price (Rp)	Available Packing
2070	A5 size / PP material	12.430,-	1/10/50
2071	A4 size / PP material	17.600,-	1/10/50



Zip Pocket

Transparent pocket with zip and punch hole. Can be used to store small items. Available in A5 and A4 size. Suitable for ring binders

Kantong transparan dengan ritsleting dan lubang binder. Dapat digunakan untuk menyimpan sampel material atau benda-benda kecil. Tersedia dalam ukuran A5 dan A4.





Business Card Pocket			
Ref	Description	Unit Price (Rp)	Available Packing
2140	A4 in Pack of 10 pcs / 20 name card	28.600,-	10/100/500
2191	235x120mm in Pack of 10 pcs/ 8 name card	19.800,-	10/200



Business Card Pocket

2140 business card pocket hold 20 cards.

2191 special business card pocket hold 8 cards. Special for Business Card Album 5596 or 7441. Packed in 10 pcs/pack.

2140 Kantong Kartu Nama, dapat menyimpan 20 kartu.

2191 Kantong Kartu Nama khusus yang dapat menyimpan 8 kartu, cocok untuk dipergunakan dengan Business Card Album 5596 atau 7441. Tersedia dalam kemasan 10 pcs/pak. Material PP 0,12 mm.



Card Holder			
Ref	Description	Unit Price (Rp)	Available Packing
2093	A3 size / 0.12 mm PP	15.730,-	1/25/100/500*
2094	A4 size / 0.12 mm PP	5.060,-	1/100/500
2095	A5 size / 0.12 mm PP	4.510,-	1/100/600

Card Holder

Made of 0.12 mm PP material, for protecting document, presentation sheets, layout etc. Photo copy safe.

Kantong kartu terbuat dari bahan PP dan aman untuk hasil fotocopy (tidak lengket), cocok untuk melindungi dokumen presentasi, layout.



Collector Pocket

Ref	Description	Unit Price (Rp)	Available Packing
2159	LS / 0,12 mm PP	41.360,-	10/100

Collector Pocket

Pocket with partition to hold 18 cards i.e. Game Card, Football Star, Movie Star, etc. Suitable for Ring Binder or Insert Ring Binder. Packed in 10 pcs/pack.

Kantong dengan partisi untuk menyimpan koleksi kartu dengan kapasitas 18 kartu dalam setiap lembarnya. Tersedia dalam kemasan 10 pcs/pak.



Signal Pocket

Ref	Description	Unit Price (Rp)	Available Packing
2050	A4 size / AntiGlare	4.840,-	1/25/100/600

Signal Pocket

The Signal pocket is equipped with a coloured mark on the right hand side, which makes it quick and easy to divide up, file and find the paper inserted. The pocket is open at the top and the upper right-hand side, which makes it easy to insert papers and means you can flick through them without removing them from the pocket.

Kantong transparan yang dilengkapi dengan signal warna (pemberi tanda) pada sebelah kanan dengan fungsi untuk memudahkan mengidentifikasi dokumen, mengklasifikasi dokumen, membagi dan menandai dokumen.

Colours:    
04 06 09 01





Adhesive A4 Pocket

Clear Vinyl and PP pocket for standard document size suitable for maintenance control cards, operating-instruction cards, documents that need full protection. Visibly store and protect documents that need to be updated frequently.



Adhesive A4 Pocket

Ref	Description	Unit Price (Rp)	Available Packing
8877 00	23 x 31 cm / 5 pcs per pack	106.920,-	1/200

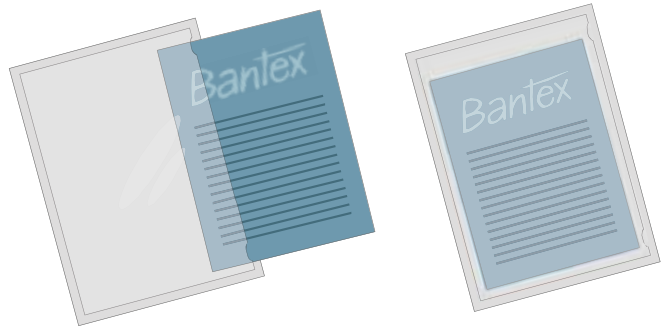

Kantung bening vinyl dan PP untuk melindungi kartu-kartu instruksi, kartu perawatan/pengendali, dalam ukuran standard. Merekat hampir pada semua permukaan. Cocok untuk mobile cabinet, panel listrik / mesin. Menyimpan & melindungi dokumen yang sering diperbaharui (diupdate) dengan tetap terlihat.



Adhesive Business Card Pocket

Ref	Description	Unit Price (Rp)	Available Packing
8876 00	10,1 x 13,5 cm / 10 pcs per pack	31.570,-	1/100



Adhesive Business Card Pocket

Adhesive pocket for business card, easy to put on. Perfect for using on your document storages, books, property, etc

Kantong transparan berpekerat untuk tempat kartu nama. Mudah ditempel. Cocok untuk ditempel pada media penyimpanan dokumen anda (map, file, binder, dsb), buku, dsb.

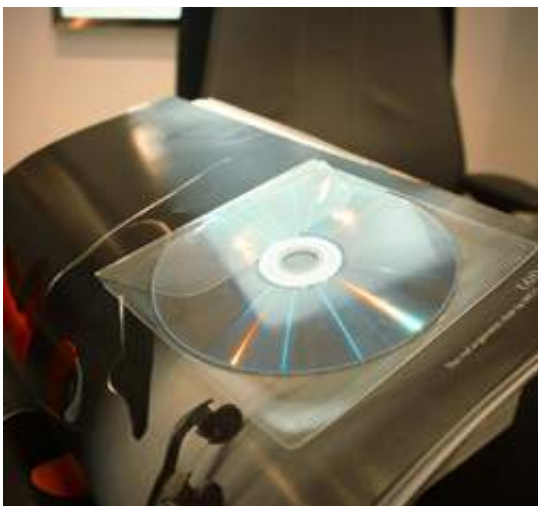

Adhesive CD Pocket

Ref	Description	Unit Price (Rp)	Available Packing
8874 00	12,2 x 12 cm / 5 pcs per pack	37.510,-	1/200

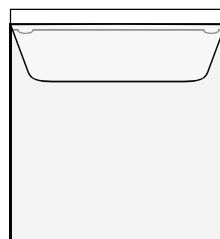

Adhesive CD Pocket

Adhesive CD pockets is ideal for storing and protecting CD/DVD media. Attach and use them wherever it's most convenient, such as in ring binders, folders and files

Kantong CD tranparan berpekerat yang cocok untuk menyimpan CD/DVD. Dapat ditempel sesuai keinginan & kebutuhan anda, misalnya pada binder, folder, ordner, dsb.

Adhesive Twin Tabs - 5 Basic Colors

Ref	Description	Unit Price (Rp)	Available Packing
8873 00	assorted color / 40 mm width / 5 colors / 6 tabs per color	33.880,-	1/200



Tabs Colors in 1 Pack:



Adhesive Twin Tabs - 5 Basic Colors

Contains 30 tabs per pack (6 tabs for each color). Writable tabs surface.

Satu pak kemasan blister berisi 30 tab (6 tab untuk setiap warna). Permukaan tab dapat ditulisi.

Adhesive Index Tabs - 5 Basic Colors

Ref	Description	Unit Price (Rp)	Available Packing
8872 00	25 mm width / 5 colors / 18 tabs per color	33.880,-	1/200



Adhesive Index Tabs - 5 Basic Colors

Contains 90 tabs per pack (18 tabs for each color). Writable tabs surface. Repositionable tab adhesive.

Satu pak kemasan blister berisi 90 tab (18 tab untuk setiap warna). Permukaan tab dapat ditulisi. Dapat digunakan sebagai pembatas buku, novel, jurnal, dsb

Tabs Colors in 1 Pack:



Adhesive Filing Strips

Ref	Description	Unit Price (Rp)	Avail. Packing
8875 00	10 pcs per pack	27.390,-	1/300

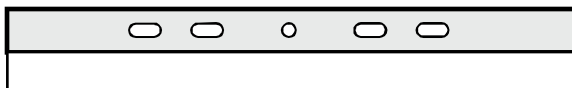

Adhesive Filing Strips

Filing strips is perfect for storing documents in ring binders & lever arch files without punching holes on the vital information printed on your paper.

Filing strips sangat cocok untuk menempatkan dokumen anda kedalam binder dan ordner tanpa perlu melubangi teks / informasi penting lainnya yang tertera di kertas anda.





Dividers & Indexes

Alat-alat pengarsipan seperti binder atau ordner memiliki fungsi untuk menyimpan & mengelompokkan dokumen dalam jumlah cukup besar. Berkas dokumen yang bersatu dalam sebuah alat arsip seringkali memiliki sub-kelompok sendiri yang perlu dipisahkan menurut pengaturan tertentu (angka, nama, tanggal, bulan, kode, dsb) dengan tujuan grouping, kerapihan, kemudahan dan efisiensi waktu akses.

Divider & Index Bantex merupakan alat bantu pengarsipan berupa lembaran yang disisipkan diantara kelompok dokumen yang ditempatkan dalam sebuah alat arsip. Divider / index Bantex berfungsi sebagai sekat, pembatas, dan penunjuk letak kelompok kelompok dokumen tsb.

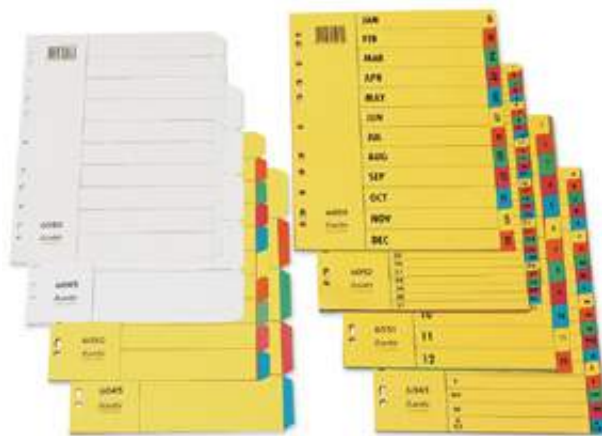

Cardboard Dividers & Indexes

Made from strong Brief Card Carton with bright colours. Strong - Line reinforced holes.

Pembatas dokumen dari material karton Brief Card yang berwarna cerah, dan diperkuat dengan Strong - Line.

Carboard Divider & Indexes				
Ref	Description	Color	Unit Price (Rp)	Available Packing
6043	A4 size - 20 pages (A-Z)	00	24.640,-	1/30/60Set
6045	A4 size - 5 pages	00; 07	6.050,-	1/100/300Set
6050	A4 size - 10 pages	00; 07	11.330,-	1/50/150Set
6051	A4 size - 12 pages (1-12)	00	14.960,-	1/25/125Set
6052	A4 size - 31 pages (1-31)	00	37.950,-	1/20/40Set
6059	A4 size - 12 pages (Jan-Dec)	00	14.960,-	1/25/125Set
8610	A5 size - 5 pages	00	3.960,-	1/40/480



Cardboard Divider			
Ref	Description	Unit Price (Rp)	Available Packing
8603	180 x 215 mm - 5 div.	5.060,-	1 Set
8602	180 x 215 mm - 4 div.	4.180,-	1 Set

Cardboard Divider

Cardboard Divider

Made from strong Brief Card Carton with bright colours. 1/2 folio size for Lever Arch File. Available with 4 dividers & 5 dividers option.

Terbuat dari karton Brief Card yang berwarna cerah. Ukuran 1/2 folio dan dapat digunakan pada ordner. Tersedia dalam 4 dividers & 5 dividers.



Reinforced with STRONG-LINE®

Bantex Cardboard is made of high quality paper material & reinforced with **STRONG-LINE®** plastic layer to make it durable & last long even for frequent use.

Colourful Cardboard

Bantex Cardboard is made of 5 colors (yellow, orange, green, red, blue) high quality paper material reinforced with **STRONG-LINE®**.

Alphabetical Indexes

Ref	Description	Unit Price (Rp)	Available Packing
6203	A4 Size / 21 pages (A-Z index)	27.830,-	1/10/80 Set

Alphabetical Indexes

Made of strong durable PP rigid with or without index sheet and photocopy safe. Available in white and grey colours.

Terbuat dari PP rigid yang dilengkapi dengan atau tanpa index sheet, yang aman untuk hasil fotokopi (tidak lengket). Tersedia dalam warna abu-abu dan putih.

Item 6203 Colours:

45



Numerical Indexes

Numerical Indexes

Made of strong durable PP. Complete with index sheet and strongline reinforced holes. Photocopy safe. Available in white and grey colours. (certain articles).

Pembatas dokumen yang terbuat dari bahan PP, dilengkapi dengan karton index dan strong line. Aman untuk hasil fotokopi (tidak lengket). Tersedia dalam warna abu-abu dan putih. (Item tertentu).

Colours:
07 05

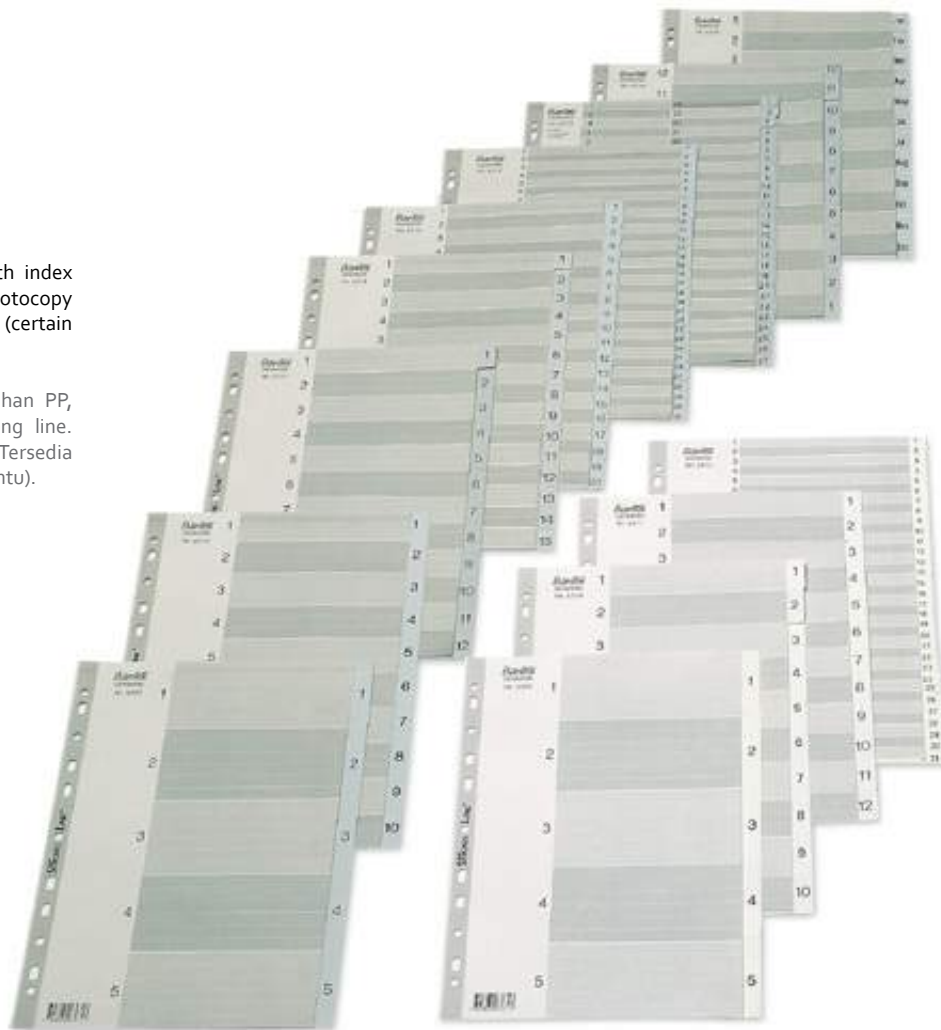

STRONG-LINE®

Strong - Line is a foil strip fitted to the index sheet, making the index sheet stronger and more durable.

Strong - Line adalah lapisan film khusus yang direkatkan pada bagian tepi berlubang index sheet sehingga tidak mudah robek dan kuat.

Numerical Indexes

Ref	Description	Unit Price (Rp)	Available Packing
6205	A4 Size / 5 pages (1-5 index) / col: 05;07	11.660,-	1/30/180Set
6206	A4 Size / 6 pages (1-6 index) / col: 05	14.300,-	1/20/160Set
6210	A4 Size / 10 pages (1-10 index) / col: 05;07	18.590,-	1/20/120Set
6211	A4 Size / 12 pages (1-12 index) / col: 05;07	22.000,-	1/20/120Set
6212	A4 Size / 31 pages (1-31 index) / col: 05;07	48.180,-	1/10/50 Set
6213	A4 Size / 20 pages (1-20 index) / col: 05	33.990,-	1/10/80 Set
6215	A4 Size / 54 pages (1-54 index) / col: 05	106.590,-	1/5/10 Set
6218	A4 Size / 15 pages (1-15 index) / col: 05	29.920,-	1/20/100 Set
6219	A4 Size / 12 pages (Jan-Dec) / col: 05	22.000,-	1/20/120 Set

Maxi Divider & Index PP

Ref	Description	Unit Price (Rp)	Available Packing
6015	A4 Maxi / 5 pages divider PP	16.500,-	100 Set
6016	A4 Maxi / 6 pages divider PP	18.810,-	1/10/60 Set
6032	A4 Maxi / 12 pages divider PP	26.510,-	1/20/120 Set
6222	A4 Maxi / 1-12 index PP	26.510,-	1/20/120 Set
6223	A4 Maxi / A-Z index PP	39.380,-	1/20 Set



Maxi Divider & Index PP

The maxi dividers and index are wider than normal A4 versions to inhibit the pockets from covering the tabs.

Maxi divider dan index lebih besar dari ukuran A4 yang normal, untuk digunakan bersama dengan kantong.

PP Colour Divider

Ref	Description	Unit Price (Rp)	Available Packing
6003	A5 - 5 pages	20.240,-	1/30/180 Set
6005	A4 - 5 pages	14.740,-	1/30/180 Set
6006	A4 - 6 pages	16.170,-	1/20/160 Set
6010	A4 - 10 pages	22.000,-	1/20/120 Set
6013	A4 - 20 pages	39.380,-	1/10/80 Set
6017	A3 Potrait - 5 pages	144.870,-	1/20 Set
6018	A3 Landscape - 5 pages	144.870,-	1/20 Set
6022	A4 - 12 pages	25.850,-	1/20/120 Set



PP Colour Divider

Made from strong durable coloured PP, complete with index sheet and featured with photocopy safe surface.

Terbuat dari bahan plastik PP yang kuat, dilengkapi dengan lembar index, aman untuk hasil cetakan / fotokopi (tidak lengket).



Eco Friendly



A5



A4

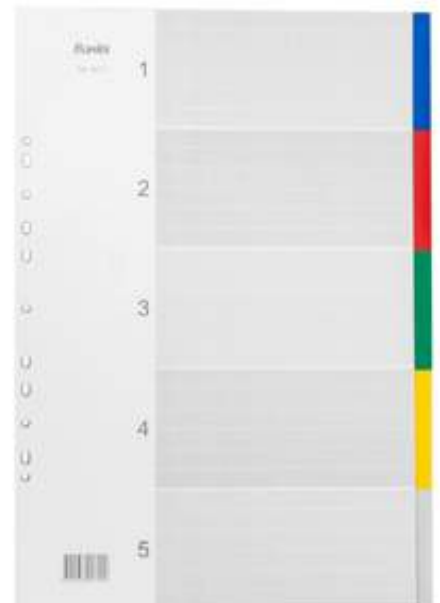

A3

Size comparisson



Bantex
Reinforced
Tabs Indexes



Reinforced Tabs Indexes

Alphabetical and numerical indexes made from strong Brief Card Carton with plastic reinforced tabs in bright colour. Strong - Line reinforced holes and index sheet.

Index abjad dan nomor terbuat dari Karton Brief Card dengan tabs plastik yang berwarna cerah. Dilengkapi dengan index dan lubang diperkuat dengan Strong - Line.



Suitable for every binder & LAF

Bantex Reinforced Tabs Indexes with 11 holes can be used in 2, 3, 4 ring binder , pipe binder & LAF



A4 R. Tabs Divider 5 Tab

A4 size brief card carton divider with 5 plain (no text, no number) bright color plastic tabs. Featured with Strong-Line reinforced holes and index sheet. **Ref 6245**



A4 R. Tabs Divider 10 Tab

A4 size brief card carton divider with 10 plain (no text, no number) bright color plastic tabs. Featured with Strong-Line reinforced holes and index sheet. **Ref 6250**



A4 R. Tabs Index Jan-Dec

A4 size brief card carton divider with 12 month text in bright color plastic tabs. Featured with Strong-Line reinforced holes and index sheet. **Ref 6259**

Reinforced Tabs Indexes (R. Tabs Indexes)

Ref	Description	Unit Price	Available Packing
6233	A4 Size / 21 pages (A-Z index)	36.410,-	1/10/70 Set
6235	A4 Size / 5 pages (1-5 index)	11.000,-	1/30/240 Set
6240	A4 Size / 10 pages (1-10 index)	19.030,-	1/20/140 Set
6241	A4 Size / 12 pages (1-12 index)	20.460,-	1/10/110 Set
6242	A4 Size / 31 pages (1-31 index)	47.520,-	1/10/50 Set
6259	A4 Size / 12 pages (Jan-Dec index)	21.340,-	1/10/110
8611	A5 Size / 5 pages (1-5 index) / 20 holes	7.260,-	1/25 Set
8607	B5 Size / 5 pages (1-5 index)	8.470,-	1/30 Set
8608	B5 Size / 10 pages (1-10 index)	14.300,-	1/20 Set

Reinforced Tabs Divider (R. Tabs Divider)

Ref	Description	Unit Price	Available Packing
6245	A4 Size / 5 pages (plain tabs)	11.220,-	1/30/240
6250	A4 Size / 10 pages (plain tabs)	19.690,-	1/20/140



Plastic Reinforced Holes

Bantex Reinforced Tabs Divider is made of high quality paper material & reinforced with strong plastic layer to make it durable & last long even for frequent use.



Plastic Reinforced Tab

Bantex Strongline Tabs is made of good quality plastic that give you smooth yet solid feel & also preserve the tab remain in a good shape & prevent colour fading.





Presentation Binders & Folders

Presentation binders & folders are some filling equipments that can be used not only to store-organize your files, but can easily serve the function as a showing, presenting, or displaying tools when you need to. Display books, flipovers, menu covers, sales-conference case are some of the items that can be classified in this category.

Binder & folder penyajian adalah peralatan-peralatan pengarsipan yang tidak hanya memiliki fungsi untuk menyimpan dan mengorganisir dokumen, namun juga dapat berfungsi sebagai alat peraga untuk memamerkan, menunjukkan, dan menyajikan data visual dengan cepat & mudah. Display book, flipover, menu cover, sales-conference case adalah beberapa item yang dapat dikelompokkan ke dalam kategori ini.

5513



Flipover Presentation Binder

Ref	Description	Unit Price (Rp)	Avail. Packing
5503	A3 Flipover Portrait, Including: 5 pcs Pocket 2037 5 pcs Paper 5507	128.150,-	1/20
5504	A4 Flipover Portrait, Including: 5 pcs Pocket 2084 5 pcs Paper 5508	96.800,-	1/20
5513	A3 Flipover Landscape, Including: 5 pcs Pocket 2036 5 pcs Paper 5517	126.500,-	1/10
5514	A4 Flipover Landscape, Including: 5 pcs Pocket 2022 5 pcs Paper 5518	70.070,-	1/20

Colours:

01 10

Flipover Presentation Binder - Landscape

Presentation binder provides a great way for your presentation and displaying material within the binder inside protective plastic sleeves. Available in A4 and A3 sizes with 4 ring mechanisms. Best use for sales kit, seminars, reception desk of hotels, restaurants, teaching's tools, MLM.



Binder display khusus presentasi yang menggunakan pocket, aman untuk hasil cetakan dan fotokopi. Tersedia dalam ukuran A4 dan A3 dengan mekanik 4 ring. Dapat dipakai untuk perlengkapan bagian penjualan, seminar, meja penerima tamu di hotel, rumah makan / restoran, alat bantu guru dalam mengajar, cocok dipakai untuk presentasi MLM.

Flipover Presentation Binders

Flipover Presentation Binder - Portrait

Presentation binder provides a great way for your presentation and displaying material within the binder inside protective plastic sleeves. Available in A4 and A3 sizes with 4 ring mechanisms. Best use for sales toolkit, seminars kit, reception desk of hotels, restaurants, teaching's tools, workshop portfolio showcase, MLM presentation.

Binder display khusus presentasi yang menggunakan pocket, aman untuk hasil cetakan dan fotokopi. Tersedia dalam ukuran A4 dan A3 dengan mekanik 4 ring. Dapat dipakai untuk perlengkapan bagian penjualan, seminar, meja penerima tamu di hotel, rumah makan/ restoran, alat bantu guru dalam mengajar, presentasi MLM.

Colours:  
01 10



Pocket for Flipover Presentation Binder

Ref	Description	Unit Price (Rp)	Avail. Packing
2022	A4 Pocket 0.08 mm for 5514 10 Pcs/bag	36.300,-	1/10 Bag
2036	A3 Pocket 0.12 mm for 5513 10 Pcs/bag	64.900,-	1/10 Bag
2037	A3 Flipover Pocket for 5503 10 Pcs/bag	64.900,-	1/10 Bag
2084	A4 Flipover Pocket for 5504 10 Pcs/bag	90.200,-	1/10 Bag
5507	A3 Flipover Paper for 5503 25 Pcs/bag	15.510,-	1/10 Bag
5508	A4 Flipover Paper for 5504 50 Pcs/bag	15.510,-	1/5 Bag
5517	A3 Flipover Paper for 5513 25 Pcs/bag	15.510,-	1/10 Bag
5518	A4 Flipover Paper for 5514 50 Pcs/bag	15.510,-	1/5 Bag

Colours: 
08

Flipover Presentation Binder - Pocket Refills

This flipover pocket refills are made from transparent high quality PP plastic. Available in regular A4 size or Large A3 size, both size came in landscape / portrait layout types.

Refill kantung flipover transparan ini terbuat dari plastik PP berkualitas. Tersedia ukuran regular A4 atau ukuran besar A3 dengan pilihan layout landscape/ portrait.

Pockets for Flipover Presentation Binders



A3 size (2036)



Display Books

With PP pockets bound into a semi rigid cover. Business card holder on front cover. Made from eco-friendly polypropylene material.

Dengan kantong PP dan cover rigid. Cover bagian depan dengan kantong kartu nama. Dibuat menggunakan material ramah lingkungan

Colours: 
65 64 09 63 61 11 10 07

Display Book			
Ref	Description	Unit Price (Rp)	Available Packing
3140	A4 Size / 10 pockets	24.750,-	1/10/30
3143	A4 Size / 20 pockets	38.280,-	1/5/25
3145	A4 Size / 40 pockets	59.070,-	1/10/20
3147	A4 Size / 60 pockets	68.860,-	1/10/20
3180	Folio Size / 10 pockets	30.250,-	1/10/30
3183	Folio Size / 20 pockets	46.860,-	1/6/30
3185	Folio Size / 40 pockets	73.150,-	1/5/20
3187	Folio Size / 60 pockets	85.580,-	1/5/20
3163	A3 Size - potrait / 20 pockets	67.540,-	1/5/25
3164	A3 Size - landscape / 20 pockets	66.220,-	1/5/25
	Colour: 07; 09; 10; 11		





Trendy Display Books

Trendy Display Book			
Ref	Description	Unit Price (Rp)	Avail. Packing
3133	A4 size / 20 pockets	26.730,-	1/5/25
3135	A4 size / 40 pockets	42.570,-	1/10/20
3393	Folio size / 20 pockets	25.300,-	1/60
3395	Folio size / 40 pockets	37.950,-	1/48

Trendy Display Book

Translucent rigid colourful covers, made of strong PP (polypropylene). Comes with 2 size option (Folio or A4) and 2 capacity option (20 or 40 strong Anti Glare PP pockets).

Cover translusen rigid berwarna cerah yang terbuat dari bahan polypropylene yang kuat. Hadir dalam 2 pilihan ukuran (Folio atau A4) dan 2 pilihan kapasitas (20 atau 40 kantong PP Anti Glare).

Colours:



08 10 11 15 19



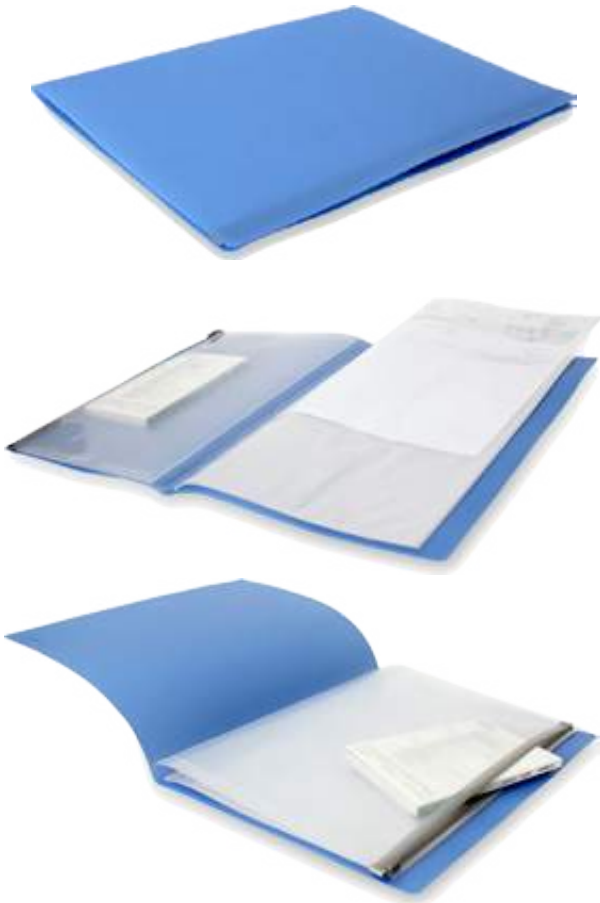

Display Books & Zipper Bag

Display book with metallic look semi-rigid cover, 10 pockets inside, FC size, and zipper pocket.

Buku Display dengan cover tampilan metalik. Berisi 10 kantong, ukuran Folio, dan dilengkapi zipper pocket.

Display Book & Zipper Bag			
Ref	Description	Unit Price (Rp)	Available Packing
3181	10 Pockets Display Book & Zipper Bag	44.990,-	1/40

Colours:

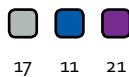

PP Insert Display Books

Display Book with clear pocket on the front & spine for insertion of printed material. Suitable for storing & displaying documents. The pockets made from non-sticky polypropylene (PP) material that are safe for printed documents. Available in A4 & Folio sizes.

Display Book dengan kantong depan & punggung yang dapat digunakan untuk memasukan hasil cetak sebagai cover/judul display book. Cocok untuk di gunakan untuk menyimpan berbagai dokumen. Pocket terbuat dari bahan polypropylene yang tidak lengket pada dokumen. Tersedia dalam ukuran A4 dan Folio.

PP Insert Display Book			
Ref	Description	Unit Price (Rp)	Available Packing
3140l	A4 Size / 10 pockets	24.750,-	1/30
3143l	A4 Size / 20 pockets	38.280,-	1/25
3145l	A4 Size / 40 pockets	59.070,-	1/20
3180l	Folio Size / 10 pockets	30.250,-	1/30
3183l	Folio Size / 20 pockets	46.860,-	1/30
3185l	Folio Size / 40 pockets	73.150,-	1/20

xx = colour codes

Colour codes:

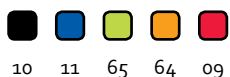

Insert Display Book

Ref	Description	Unit Price (Rp)	Available Packing
3174	A4 Size / 10 pockets	22.000,-	1/10/30
3175	A4 Size / 20 pockets	35.200,-	1/5/25
3176	A4 Size / 40 pockets	54.780,-	1/10/20

Insert Display Book

Display Book with clear pocket on the front cover for insertion of printed material etc. With strong PP. Pockets bound into a rigid cover and photo copy safe.

Buku display dengan kantong bening di cover depan untuk memasukkan hasil cetakan/judul. Kantong PP yang tebal disatukan dengan cover yang solid dan aman untuk hasil photo copy (tidak lengket).

The printed design on this insert cover shown here is not a part of the standard product, this is an illustration that you can fill the pocket cover with your own printing material.

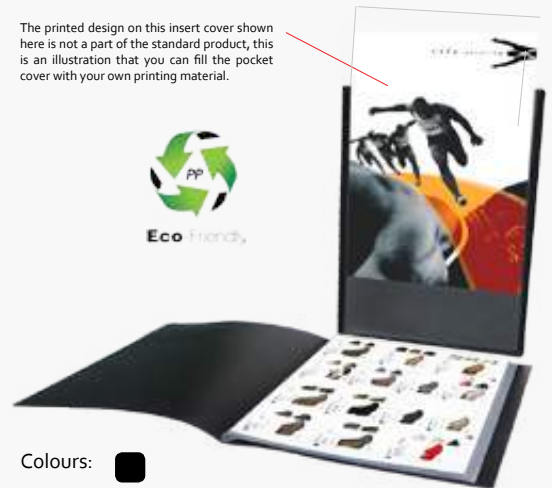

Colours: 
10

Exclusive Display Book

Ref	Description	Unit Price (Rp)	Available Packing
8820 10	A4 Size/ 24 Pockets	91.410,-	1/12/72
8821 10	FC Size/ 24 Pockets	105.270,-	1/12/72

Exclusive Display Book

24 Pockets display book made from high quality PP material in solid build quality, give an exclusive look & feel to this product.

Buku display dengan 24 kantong display, terbuat dari bahan ramah lingkungan berkualitas, dengan kualitas buatan terbaik menjadikan produk ini memiliki tampilan premium yang eksklusif.

Colours: 
10





Display Book - Refillable

Ref	Description	Unit Price (Rp)	Available Packing
3165	A4 Size / 20 pockets	74.250,-	1/10/40

Display Book Refillable

The refill pocket could easily added to this display book according to own your need.

Buku display dengan kantong antiglare (kulit jeruk). Kantong PP yang tebal disatukan dengan cover transparan yang solid Khusus untuk display book Ref. 3165 disediakan refill.

Colours: 
 08 04 01 10

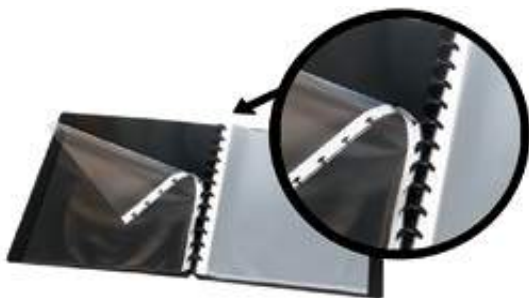

Pockets for Display Book - Refillable

Ref	Description	Unit Price (Rp)	Available Packing
3166	A4 size / for Refill item 3165 / 0.07 mm thickness / 10 pieces per pack	17.600,-	10/500

Colours: 
 08

Pockets for Display Book Refillable

Special pocket for the refillable display book of Ref. No. 3165. It's easily to install/ fit.

Kantong plastik isi ulang, terdapat 12 slot untuk menaruh kantong plastik di Display Book. Kantong plastik isi ulang untuk Display Book Ref. 3165.

Display Book - Transparent

Ref	Description	Unit Price (Rp)	Avail. Packing
3155	A4 Size/Transparent/ 20Pockets	39.270,-	1/10/60
3156	Folio Size/ Transparent/20Pockets	48.400,-	1/6/30

Display Book - Transparent

Now comes with transparent rigid colourful covers, made of strong PP (polypropylene).

Buku display dengan kantong antiglare (kulit jeruk). Kantong PP yang tebal disatukan dengan cover transparan yang solid.

Colours: 
 08 07 05 10 21 01 11 15 04





Sorter Book			
Ref	Description	Unit Price (Rp)	Avail. Packing
E42414	A4 Size / Tabs A-Z	580.250,-	1
E42416	A4 Size / Tabs Jan-Dec	398.090,-	1
E42418	A4 Size / Tabs 1-31	871.750,-	1

Sorter Book

For clear and orderly collection, sorting and scheduling of documents. Strong fibre board, expanding cloth back, partition sheets in grey manila 320 gr/m, with plastic tabs and see-through holes.

Untuk mendapatkan penyusunan dokumen yang rapi. Seperti dokumen yang jatuh tempo. Terbuat dari lembar fiber yang kuat. Terdapat lubang disetiap lembar untuk memudahkan melihat informasi pada setiap lembar berikutnya.



Colours: 10

Signature Book			
Ref	Description	Unit Price (Rp)	Available Packing
E41403	A4 Size	550.660,-	1

Signature Book

Signature books, with strong laminated PP cover. For A4, size 20 divisions, expanding cloth back plasticbound.

Buku tanda tangan yang diperkuat dengan sampul dari bahan PP yang dilaminasi. Terdiri dari 20 bagian. Cocok dipakai untuk Notaris atau Kantor Pengacara, Bank dan Asuransi.

Colours:
10 05 04 14 11



Organizer & Signature			
Ref	Description	Unit Price (Rp)	Available Packing
3170	A4 Size	71.390,-	1/10/60

Colours: 10

Organizer & Signature

Made of PP, A4 Sizes with 8 coloured division/parts. Include with pockets for insert and elastic locking straps.

Terbuat dari bahan PP, ukuran A4 dengan 8 bagian yang memiliki warna berbeda. Dilengkapi kantong untuk index dan tali pengunci yang elastis.





Eco-Friendly

Type 3230
Quotation Folders

Quotation Folders with Coloured Back Cover

Ref	Description	Unit Price (Rp)	Available Packing
3230	A4 Size	6.710,-	1/50
3231	Folio Size	7.480,-	1/50

Quotation Folders

A4 & Folio size folders with glass clear front and colour matched spine and back cover. With interchangeable spine label. Made from eco-friendly polypropylene (PP) material. Safe for copier printed paper.

Folder penawaran ukuran A4 & folio dengan cover depan bening, warna cover belakang sama dengan punggung yang dilengkapi label yang dapat diganti. Terbuat dari bahan polypropylene (PP) yang aman untuk hasil fotocopy (tidak lengket).





Eco friendly



Presentation / Insert Quotation Folder

Hard wearing deluxe quotation folder with double clear front cover for insert and back cover with transparent pocket on inner back cover.

Quotation folder deluxe yang tahan lama, dengan cover depan bening ganda di bagian depan untuk insert dan cover belakang dengan kantong bening pada sisi dalamnya.



Presentation/Insert Quotation Folder

Ref	Description	Unit Price (Rp)	Available Packing
3210	A4 Size	36.080,-	1/25

Colours:
10 07



Eco friendly



Manager File

Front & back cover in rigid PVC with pocket and label on front cover and clear pocket on inner front cover.

Cover terbuat dari PVC rigid. Cover depan luar dilengkapi dengan kantong dan label. Cover depan dalam dengan kantong bening.

Manager File

Ref	Description	Unit Price (Rp)	Available Packing
3420	A4 Size	37.180,-	1/90

Colours:
04 01 09





Clip Files

Clip file front cover is made from transparent PP plastic. The spine side equipped with metal clip for holding unpunched paper easily, so you can store document without punching holes in it. Paper content capacity around 5 mm.

Clip file memiliki cover depan dari bahan PP transparan. Bagian sisinya dilengkapi dengan clip metal untuk memegang/menjejit kertas dengan cepat dan mudah sehingga anda tidak perlu melubangi kertas untuk menyimpan dokumen di dalamnya. Kapasitas isi 5 mm.

Colours: 
10 07 09 11 01

Clip File			
Ref	Description	Unit Price (Rp)	Available Packing
3260	A4 Size / metal clip	13.090,-	1/12/48/240
3261	Folio Size / metal clip	14.740,-	1/12/48/240

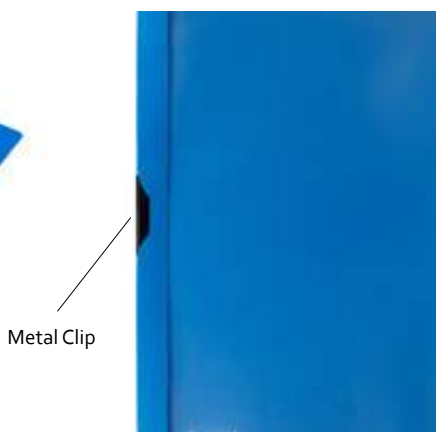

Prong Paper Fasteners

Ref	Description	Unit Price (Rp)	Available Packing
11792 00	Prong Paper - 50 pcs	54.670,-	1/10/50

Prong Paper Fasteners

Prong Paper Fasteners made of high quality steel with safety edges. Anti rust with 5 cm capacity and 8 cm hole centre.

Terbuat dari besi anti karat dengan kualitas yang baik. Produknya aman dan tidak tajam, dengan kapasitas 5 cm serta jarak antara lubang 8 cm.



related item from other brand

ELBA

Self Adhesive Filing Strip

Ref	Description	Unit Price (Rp)	Available Packing
E27595	metal prong material / plastic compressor bar	6.490,-	1/100

Self Adhesive Filing Strip

Strip for files and folders, with metal prong and plastic compressor bar

Strip yang dapat digunakan sebagai alat membundel dokumen dalam bentuk lembaran. Terbuat dari besi dengan kompresor plastik. Dapat ditempel di mana saja.



ELBA

ELBA

Insertion Filing Strip

Ref	Description	Unit Price (Rp)	Available Packing
E27592	Insertion Filing Strip	2.640,-	1/100

Insertion Filing Strip

For vertic files and folders and insertion folders.

Digunakan sebagai alat tambahan untuk menyimpan dokumen. Digunakan dengan hang map ELBA.



Hang Map / Suspension Files

Made of high quality Brief Card, supplied with 50 mm tabs and insert strips. One box contents 200 pieces.

Hang map yang dibuat dari karton Manila berkualitas dengan warna-warna biru, hijau, kuning, merah yang cemerlang, juga warna putih dan hijau gelap. Dilengkapi tabs 50 mm dengan label. Satu box isi 200 buah.



Suspension File			
Ref	Description	Unit Price (Rp)	Available Packing
3460	A4 Size	9.680,-	1/25/200
3470	Folio Size	10.230,-	1/25/200
3490	Tab for suspension file	22.000,-	1/25/1500

Colours: 
 11 15 04 06 09 07

5 Keunggulan Suspension File Bantex:

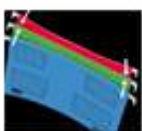

Baja penahan kertas karton pada hang map tidak mudah karat & lentur



Fungsi lubang pada bagian dalam berfungsi sebagai tempat prong paper fastener Ref. 11792 00 (dijual secara terpisah)



Ujung besi penahan tidak tajam & tidak melukai tangan

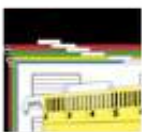

Dilengkapi dengan tab, 9 tempat posisi tab untuk ukuran A₄, sedangkan Folio 11 tempat posisi tab memudahkan identifikasi



Terbuat dari kertas karton kualitas terbaik



Suspension / Computer File Trolley

Solid, lacquered metal. Suitable & adjustable for Suspension File 3460 or 3470, also for 1562 & 1564 series. Could be placed easily around your office. (see specification on page 25)

Troli dengan konstruksi yang di vernish / dilapisi metal. Kuat, fleksibel dan mudah dipindah tempatkan. Dapat digunakan untuk semua jenis suspension file dan seri 1562 serta 1564 (lihat spec. [hlm 25](#)).



Suspension Filing Tray

Ref	Description	Unit Price (Rp)	Avail. Packing
8845 05	Suspension Filing Tray Foolsap (FC) / A4 - adjustable	311.300,-	1/10
8845 10	Suspension Filing Tray Foolsap (FC) / A4 - adjustable	311.300,-	1/10

Colours:
10 05

Suspension Filing Tray

Made of high quality moulded plastic. Quick and easy assembly, and could be used both for A4 or FC sizes. Can be mounded on wall, stackable one on another. Organizes small office and personal accessories. Bantex suspension filing tray is a compact tray for A4 or FC suspension file.

Terbuat dari plastik dengan kualitas yang sangat baik. Cepat dan mudah dirakit dan dapat digunakan untuk untuk map gantung dengan ukuran A4, atau FC. Dapat juga digantung/diletakkan pada dinding. Tray ini dapat ditumpuk satu dengan yang lainnya. Tepat dipakai untuk kantor-kantor kecil dan kantor proyek.

Suspension Filing Tray

For Hang Map / Suspension File



Acrylic Suspension Boxes

High quality glass clear Acrylic Suspension File Box for display or table modul with top opening, provide a dust-free ground.

Kotak akrilik bening tempat hang map untuk media pajang atau penyimpanan. Dilengkapi panel sisi atas yang dapat dibuka tutup, membuat dokumen selalu bersih dan bebas dari debu.

Acrylic Suspension Box

Ref	Measurement (HxLxD) & Description	Unit Price (Rp)	Available Packing
1666	28 x 38 x 24 / For A4	866.800,-	1
1667	28 x 43 x 24 / For Folio	909.260,-	1

Colours: 
08





Go-Fix Suspension Filing Rack

* Elba Go-Fix suspension filing rack/tray (E84410) shown with Bantex Suspension file (3460 o6)



Go-Fix			ELBA
Ref	Measurement (HxLxD) & Description	Unit Price (Rp)	Available Packing
E84410	27.6 x 36.3 x 33.2 cm / For A4	311.410,-	1

Go - Fix
Suspension filing rack, Elba design, unassembled for A4, without folders.

Rak untuk tempat hang map. Desain dari Elba. Dapat dirakit sendiri. Ukuran A4, tanpa folder.



Suspension File			
Ref	Description	Unit Price (Rp)	Available Packing
3460	A4 Size	9.680,-	1/25/200
3470	Folio Size	10.230,-	1/25/200
3490	Tab for suspension file	22.000,-	1/25/1500

Suspension File
Made of high quality Brief Card, supplied with 50 mm tabs and insert strips. One box contents 200 pieces.

Terbuat dari karton manila berkualitas dengan warna-warna biru, hijau, kuning, merah, putih dan hijau gelap. Dilengkapi tabs 50 mm dengan label. Jumlah Item per box: 200 buah.





Optima Letter Tray

Document Tray



Document Tray Optima			
Ref	Description	Unit Price (Rp)	Available Packing
9826	6 Organiser / col: 08	89.760,-	1/6
9862	Plastic Moulded Letter Tray / col: 01; 04; 08; 10; 14; 25	90.420,-	1/10
9863	Plastic Riser - 4pcs. / col: 08	26.400,-	1/20

Document Tray Optima

Optima letter tray and organiser set. Modern ergonomic design, made of high quality solid/ clear transparent plastic. Helps you removes clutter form desk, include with riser sets. Stackable format.

Desain modern yang ergonomis. Terbuat dari bahan plastik solid/ plastik transparan berkualitas terbaik. Membantu mengorganisir area kerja anda. Dilengkapi dengan 1 set riser. Dapat ditumpuk satu dengan yang lainnya.

Colours:

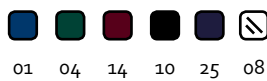



Letter Tray Set & Desk Manager

Ref	Description	Unit Price (Rp)	Available Packing
9870	Letter Tray 9870	48.400,-	1/10
9872	2 Letter Tray 9870, equipped with Riser & Desk Manager	122.320,-	1 set
9815	Desk Manager / col: 10	21.230,-	1
9811	Set of 4 pins "Risiers"	2.860,-	1 set



Letter Tray Set & Desk Manager

Stackable letter tray (350x250x60mm) to place your active documents for easy access. Available in several colours. Available by sets or separated parts.

Letter tray tingkat (350x250x60mm) untuk menempatkan dokumen aktif sehingga mudah untuk di akses. Tersedia dalam beberapa pilihan warna. Tersedia dalam part satuan atau paket set.

9870 Colours:



9870



9811

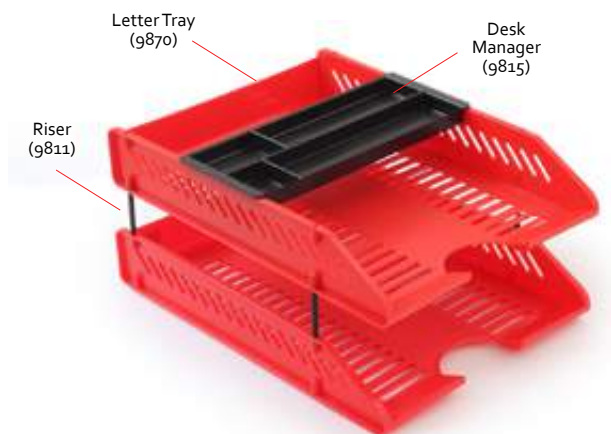

Letter Tray (9870)

Desk Manager (9815)

Riser (9811)

747

Sales &
Conference
Case

~~~ SERIES ~~~

## 747 Sales & Conference Case

| Ref     | Description                    | Unit Price (Rp) | Avail Pack |
|---------|--------------------------------|-----------------|------------|
| 7455 03 | Sales and Conference Case / A4 | 108.680,-       | 1/24       |
| 7455 10 | Sales and Conference Case / A4 | 108.680,-       | 1/24       |
| 7455 14 | Sales and Conference Case / A4 | 108.680,-       | 1/24       |



### 747 Sales & Conference Case

With pen holder, writing pad, pockets for business card, telephone list (or credit cards pockets), 16 mm 4 ring mechanism with 4 pockets for sales leaflet.

Map Conference atau Sales dengan tempat pen, blok note, tempat kartu nama, daftar nomor telepon (juga untuk tempat kartu kredit), dengan mekanik 4 ring 16 mm dan 4 buah, kantong untuk leaflet.

Colours:     
03 10 14

## 747 Clipholder

| Ref  | Description          | Unit Price (Rp) | Available Packing |
|------|----------------------|-----------------|-------------------|
| 7415 | Clipholder / A4 size | 83.490,-        | 1/60              |

**747 Clipholder**

Ideal for order form memos, notes, etc. with clip, pen holder and inside pocket.

747 Clipholder cocok untuk formulir order dengan clip mekanik dan gantungan pen serta kantong dalam.

Colours:     
03 10 14



## 747 Business Card Album

| Ref  | Description                                         | Unit Price (Rp) | Available Packing |
|------|-----------------------------------------------------|-----------------|-------------------|
| 7441 | Business Card Album                                 | 106.590,-       | 1/36              |
| 2191 | Special Business Card Pocket for 7441 in pack of 10 | 19.800,-        | 1/10/1000         |

**747 Business Card Album**

With 4 ring mechanism holding 20 PP business card pockets, for 160 cards include with 80 pieces empty name cards for insertion.

747 Album Kartu Nama dengan mekanik 4 ring isi 20 lembar. Pocket PP untuk 160 kartu nama dan dilengkapi 80 lembar kartu nama kosong.

Colours:     
03 10 14



## 747 Ring Binder

| Ref  | Description                  | Unit Price (Rp) | Available Packing |
|------|------------------------------|-----------------|-------------------|
| 7425 | Ring Binder / A4 size        | 88.990,-        | 1/18              |
| 7426 | Ring Binder / F (Folio) size | 95.370,-        | 1/18              |

**747 Ring Binder**

Ring Binder with 2D - Ring 25 mm mechanism. (Other ring capacity available on request).

Map ring terbuat dari kulit dengan mekanik 2D kapasitas 25 mm. (Mekanik ukuran lain dapat dilayani).

Colours:     
03 10 14





### 747 Desk Pad

| Ref  | Description              | Unit Price (Rp) | Available Packing |
|------|--------------------------|-----------------|-------------------|
| 7460 | Desk Pad / 63 x 46 cm    | 120.010,-       | 1/10              |
| 8060 | Refill Desk pad Calender | 32.230,-        | 1                 |

#### 747 Desk Pad

With green blotting paper and pockets at each side of desk pad.

Alas meja 747 yang eksklusif dengan alas tulis warna hijau dan kantong pada 2 sisi. Termasuk agenda bulanan tanpa tanggal.

Colours:     
03 10 14



### 747 Menu Cover

| Ref  | Description         | Unit Price (Rp) | Available Packing |
|------|---------------------|-----------------|-------------------|
| 7422 | Menu Cover / 2 x A4 | 100.980,-       | 1/24              |
| 7423 | Pocket 2 x A4       | 15.180,-        | 1/10/50           |

#### 747 Menu Cover

With PP pocket which are safe to photocopy material. The pocket can easily be removed and number of pocket is variable. Supplied with 3 pockets. Extra pockets are available.

Menu Cover terbuat dari bahan PP yang aman untuk hasil fotokopi. Kantong mudah untuk dilepas dan dilengkapi nomor yang bervariasi. Dilengkapi dengan 3 kantong untuk menu. Kantong ekstra bisa didapat atas permintaan.

Colours:     
03 10 14



### 747 Telephone & Address Book

| Ref  | Description                        | Unit Price (Rp) | Avail. Packing |
|------|------------------------------------|-----------------|----------------|
| 7440 | Telp and Address Book - 15 x 23 cm | 61.160,-        | 1/60           |

#### 747 Telephone & Address Book

Address book, with 4 ring mechanism holding alphabetical index.

Buku alamat dan telephone 747 dengan mekanik 4 ring dan index abjad.

Colours:     
03 10 14



### 747 Conference Case

| Ref  | Description               | Unit Price (Rp) | Available Packing |
|------|---------------------------|-----------------|-------------------|
| 7445 | Conference Case / A4 size | 106.920,-       | 1/24              |

#### 747 Conference Case

With pen holder, writing pad, pocket for telephone list and business cards (can be used as credit cards pocket), space for data bank.

747 Conference Case dilengkapi dengan tempat pen, kantong untuk daftar nomor telepon dan kartu nama (bisa juga digunakan sebagai tempat kartu kredit atau untuk data bank).

Colours:     
03 10 14



### 747 Writing Case

| Ref  | Description            | Unit Price (Rp) | Available Packing |
|------|------------------------|-----------------|-------------------|
| 7400 | Writing Case / A4 size | 87.670,-        | 1/24              |
| 7401 | Writing Case / FC size | 84.810,-        | 1/36              |
| 7410 | Writing Case / A5 size | 61.050,-        | 1/36              |

#### 747 Writing Case

With pen holder, inside pocket and writing pad.

Map dengan dilengkapi tempat pena, kantong dalam dan blok note.

Colours:     
03 10 14



### 747 Sales & Order Case

| Ref  | Description               | Unit Price (Rp) | Available Packing |
|------|---------------------------|-----------------|-------------------|
| 7456 | Sales and Order Case / A4 | 104.060,-       | 1/24              |

#### 747 Sales & Order Case

With 4 ring mechanism holding 5 pockets and clip mechanism. Inside pocket with clear pocket for business card and telephone list.

Map penjualan dan pesanan dengan 5 buah kantong PP untuk leaflet dan mekanik clip untuk order form. Terdapat kantong kartu nama dan daftar nomor telepon.

Colours:     
03 10 14





# Personal Document

Equipped with 20 sheet of document safe - polypropylene pockets. Serve the purpose of personal document display & storage. With refillable mechanism, additional pockets can be added easily to this products to suit your needs.

Dilengkapi pocket berbahan polypropylene yang tidak lengket pada document. Fungsi untuk menyimpan dokumen pribadi seperti Ijasah, Kartu Keluarga, Akte Lahir, dll. Terdiri dari 20 lembar pocket yang dapat di lepaskan dengan mudah dan tersedia refill untuk menambah jumlah pocket sesuai kebutuhan.

Colours:      
09 10 01 62

| Personal Document |                              |                 |            |
|-------------------|------------------------------|-----------------|------------|
| Ref               | Description                  | Unit Price (Rp) | Avail Pack |
| 3153 09           | Personal Document 20 Pockets | 97.460,-        | 1/10       |
| 3153 10           | Personal Document 20 Pockets | 97.460,-        | 1/10       |
| 3153 01           | Personal Document 20 Pockets | 97.460,-        | 1/10       |
| 3153 62           | Personal Document 20 Pockets | 97.460,-        | 1/10       |



### Optima Magazine Filing Box

| Ref  | Description      | Unit Price (Rp) | Available Packing |
|------|------------------|-----------------|-------------------|
| 9860 | Plastic material | 125.070,-       | 1/6               |

Colours:   
08 04 01 10 25 14



# Optima Magazine Filing Box

## Optima Magazine Filing Box

A4 - Moulded plastic. 70mm capacity with self adhesive label holder. Colour coded spine label. Label is not affixed to the product.

Cocok untuk ukuran A4. Terbuat dari plastik cetak. Kapasitas 7cm, disertakan dengan tempat/ kantong label yg dapat dilepas - tempel.



### Jumbo Knock Down, Magazine File

| Ref  | Description                 | Unit Price (Rp) | Available Packing |
|------|-----------------------------|-----------------|-------------------|
| 9851 | Folio Maxi - 10 cm capacity | 81.730,-        | 1/30              |

## Jumbo Knock Down, Magazine File

New design knock down jumbo magazine file, 10 cm spine width. Suitable for FC folder. Stable construction, easy assembling.

Magazine file dengan desain baru yang terurai dalam elemen yang mudah dipasang dengan konstruksi yang kokoh. Lebar punggung 10 cm, ukuran FC, dan stopmap bisa masuk.

Colours:   
09 11 01 10 05



Assembled

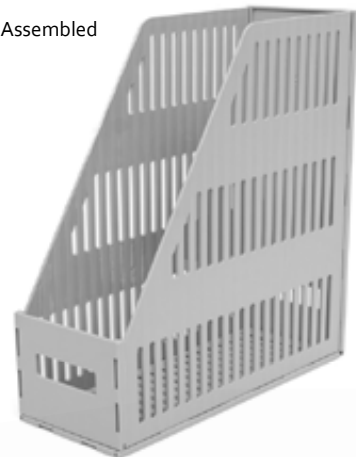

Knocked Down

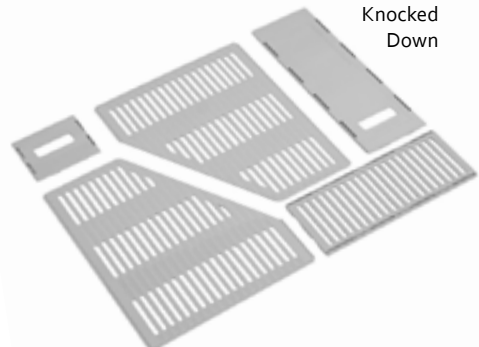

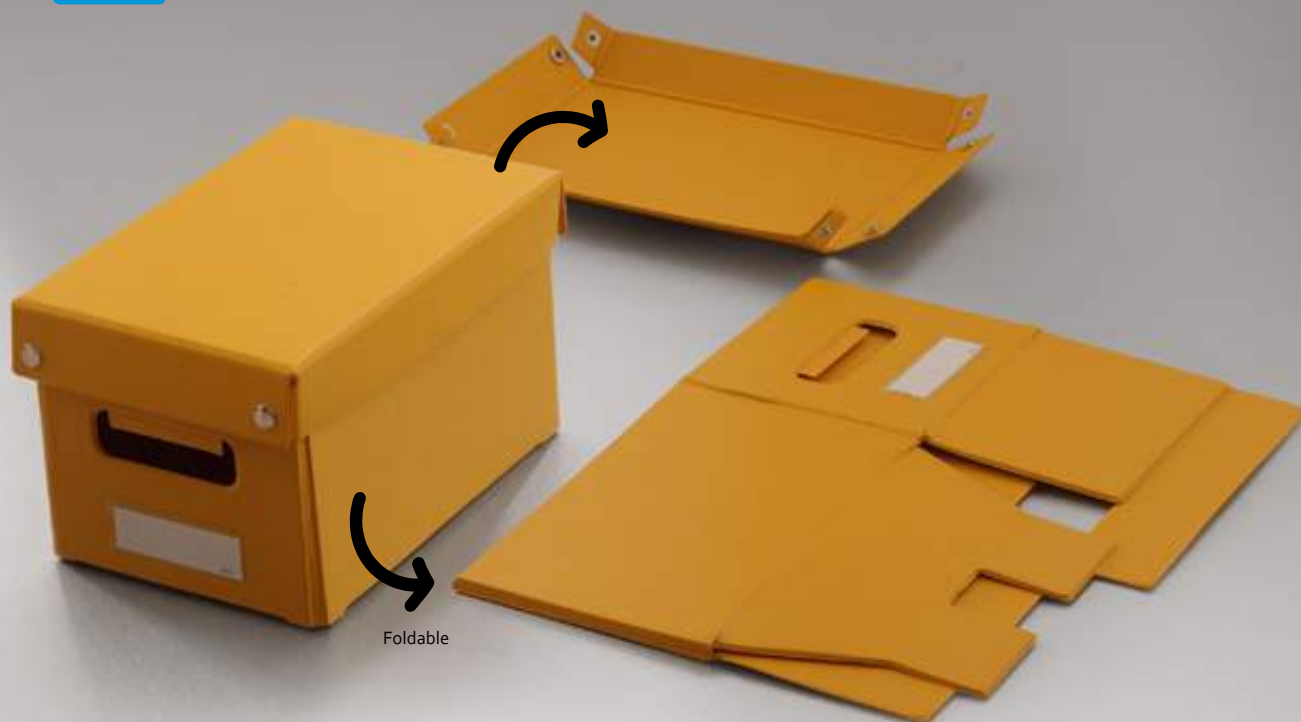

# Easy Box

Bantex 'Easy Box' is a multifunction boxes made from high quality boards. This product designed to be a flexible storage compartment storage that can be folded when not in use. Made from high quality-strong-water resistant materials, 'Easy Box' is made to last. Suitable for storing documents, books, magazine, electronics, apparels, or any other stuff, supplies, or equipment. Available in 5 color options in Large & Medium size.

| Easy Box |                               |                 |                   |
|----------|-------------------------------|-----------------|-------------------|
| Ref      | Description                   | Unit Price (Rp) | Available Packing |
| 8920     | Easy Box L<br>(600x500x250mm) | 168.190,-       | 1/13              |
| 8921     | Easy Box M<br>(410x320x225mm) | 112.750,-       | 1/16              |

Box multifungsi "Easy Box" menggunakan board berkualitas. Digunakan sebagai tempat penyimpanan multifungsi seperti dokumen, buku, majalah, dan barang-barang penting lainnya. Lebih kuat, awet dan tahan lama, dilapisi oleh plastik dan tidak menyerap air, melindungi dokumen, buku, majalah, dan barang penting yang ada didalamnya. Dapat dibentuk dan dilipat dengan mudah, serta tidak memerlukan ruang yang banyak untuk penyimpanan. Tersedia 5 varian warna dalam ukuran Large & Medium.



8920

8921

Colours:



10 09 11 04 06



| Magazine Files |                            |                 |                   |
|----------------|----------------------------|-----------------|-------------------|
| Ref            | Description                | Unit Price (Rp) | Available Packing |
| 4010           | A4 size / 7cm capacity     | 31.900,-        | 1/30              |
| 4011           | Folio size / 10cm capacity | 40.150,-        | 1/25              |
| 4012           | A4 size / 10cm capacity    | 37.290,-        | 1/25              |

Colours:

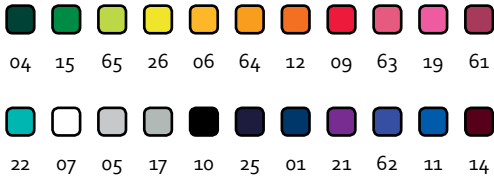

# Magazine Files

Box Files

## Magazine Files

Made of hardboard covered with plastic. Store more magazines and document in one box. Collapsible, 7 cm spine as Lever Arch File Jumbo 10 cm. Spine with double interchangeable spine label.

Terbuat dari karton dan dilapisi dengan plastik. Dapat menyimpan lebih banyak majalah dan dokumen dalam satu kotak. Box File, bisa dilipat, lebar punggung 7 cm, ukuran jumbo lebar punggung 10 cm dengan kantong label depan belakang.

| Document Portfolio |                                         |                 |             |
|--------------------|-----------------------------------------|-----------------|-------------|
| Ref                | Description                             | Unit Price (Rp) | Avail. Pack |
| E31414             | A4 size / 4cm capacity / fibre material | 135.300,-       | 1           |
| E31416             | A4 size / 6cm capacity / fibre material | 163.680,-       | 1           |
| E31418             | A4 size / 8cm capacity / fibre material | 167.750,-       | 1           |

## Document Portfolio

Made of fibreboard with 3 flaps, with snap fastener, can be laid flat or used upright, for size A4.

Terbuat dari bahan fiber dengan 3 sisi, dilengkapi dengan pengunci. dapat digunakan secara berdiri atau ditaruh. Ukuran A4.



Colours:



10



**Bantex**

Portable Case  
with Handle

Colours:



Portable Case with Handle

| Ref  | Description               | Unit Price (Rp) | Available Packing |
|------|---------------------------|-----------------|-------------------|
| 3611 | Portable Case With Handle | 77.440,-        | 1/10              |

**Portable Case with Handle**

Document case made from flexible PP with metallic look texture, FC size, 4cm capacity, a smart lock and handle on top of it.

Kotak penyimpanan dokumen terbuat dari bahan PP yang flexibel dengan tampilan tekstur metalik, ukuran Folio, kapasitas 4 cm, pengunci, dan pegangan di atasnya.



## Poly Wallet Case &amp; Cheque

| Ref  | Description                    | Unit Price (Rp) | Available Packing |
|------|--------------------------------|-----------------|-------------------|
| 8013 | A4 with button - 2 Divider     | 31.240,-        | 1/6               |
| 8014 | Cheque with button - 2 Divider | 23.320,-        | 1/6               |
| 8015 | FC with button - 2 Divider     | 35.970,-        | 1/6               |

Colours:



15 12 19 21



Eco friendly

# Poly Wallet Case & Cheque

Poly wallet serves you an easy simple filing and easy cheques organizing. Made from translucent eco-friendly PP material. Featured with 2 dividers and 3 pockets. Available in 3 size, Folio, A4, and mini / cheque size.

Poly wallet memberikan anda pengarsipan sederhana mudah untuk penyimpanan file, cek dan giro bank. Terbuat dari material translucent PP yang ramah lingkungan. Dilengkapi 2 divider/pembatas dan 3 kantong. Tersedia dalam ukuran Folio, A4, dan mini.





## Expanding File w/ Zipper Pocket

Made of hard-wearing flexible PP with metallic look texture, FC size, 13 Pockets with tabs and paper insert, with elastic locking straps. Equipped with zipper pocket.

Map harmonika terbuat dari bahan PP yang flexible dengan tampilan tekstur metalik. Ukuran Folio dilengkapi dengan 13 kantong, tab, kertas penanda, dan tali pengunci elastis. Dilengkapi fitur tambahan berupa zipper pocket.

### Expanding File with Zipper Pocket

| Ref  | Description                              | Unit Price (Rp) | Available Packing |
|------|------------------------------------------|-----------------|-------------------|
| 3602 | FC Size, 13 pockets, front zipper pocket | 112.420,-       | 1/20              |



Eco-Friendly

Colours:



11 21 17





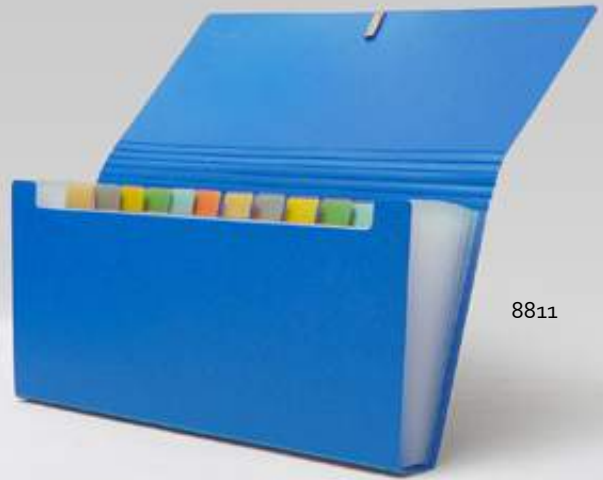

8811

| Expanding File for Cheque |             |                 |                   |
|---------------------------|-------------|-----------------|-------------------|
| Ref                       | Description | Unit Price (Rp) | Available Packing |
| 8810                      | 6 Pockets   | 41.470,-        | 1/6/60            |
| 8811                      | 12 Pockets  | 49.830,-        | 1/10/60           |

- Colours:
- 10
  - 11
  - 65
  - 64
  - 63
  - 61
  - 09

## Expanding Files for Cheque

Made of hard-wearing, flexible PP with 6 pockets for 8810 and 12 pockets for 8811. Include paper tabs and elastic locking straps. Easy filing for your cheques.

Map harmonika terbuat dari bahan PP dilengkapi dengan 6 kantong untuk 8810 dan 12 kantong untuk 8811. Dilengkapi pembatas dan tali pengunci elastis. Memudahkan untuk pengarsipan Cek/Giro Bank.



8810



**Bantex**  
Expanding File  
with Handle



Expanding File with Handle

| Ref  | Description                   | Unit Price (Rp) | Available Packing |
|------|-------------------------------|-----------------|-------------------|
| 3603 | FC Size / 13 Pockets with tab | 116.710,-       | 1/20              |

Colours:



Eco friendly



**Expanding File with Handle**

Made of hard-wearing flexible PP with metallic look texture, FC size, 13 Pockets with tabs and paper insert, with smart lock. A handle on top so you can carry around with ease.

Map harmonika terbuat dari bahan PP yang flexible dengan tampilan tekstur metalik. Ukuran Folio dilengkapi dengan 13 kantong, tab, kertas penanda, dan pengunci. Terdapat pegangan diatas map untuk memudahkan dibawa. Contoh penggunaan: penyimpanan surat berharga, dokumen, akta, dsb.



| Expanding File - PP |             |                 |                   |
|---------------------|-------------|-----------------|-------------------|
| Ref                 | Description | Unit Price (Rp) | Available Packing |
| 3600                | A4 Size     | 65.560,-        | 1/6/48            |
| 3601                | Folio Size  | 78.650,-        | 1/10/40           |

Colours:



# Expanding File

Made of hard-wearing, flexible PP, 12 pockets with tabs and paper insert, with elastic locking straps and business card pocket on the front cover.

Map harmonika, terbuat dari bahan PP yang fleksibel. Dilengkapi dengan 12 kantong, tabs, insert dan tali pengunci elastis.





## Index L Folder

Keep actual letter/document with top and side opening made from PP material. Segmented in 5 different space in 1 folder with tabs.

Untuk menyimpan surat-surat atau dokumen aktual. Terbuat dari bahan PP lunak. Terbagi menjadi 5 ruang terpisah dalam 1 folder. Dilengkapi tabs.



## Multi L Folder

Keep actual letter/document with top and side opening made from PP material. Segmented in 6 different pockets in 1 folder.

Untuk menyimpan surat-surat atau dokumen aktual. Terbuat dari bahan PP lunak. Terbagi menjadi 6 ruang kantong dalam 1 folder.

| Index L Folder |                                   |                 |                |
|----------------|-----------------------------------|-----------------|----------------|
| Ref            | Description                       | Unit Price (Rp) | Avail. Packing |
| 8879           | A4 Size/ PP Material / 5 Dividers | 18.920,-        | 1              |

Silk Screen Colours: (warna sablon)

11
  15
  19

| Multi L Folder |                                       |                 |                |
|----------------|---------------------------------------|-----------------|----------------|
| Ref            | Description                           | Unit Price (Rp) | Avail. Packing |
| 8878 11        | A4 Size/ PP Material / 6 in 1 Folders | 29.370,-        | 1              |

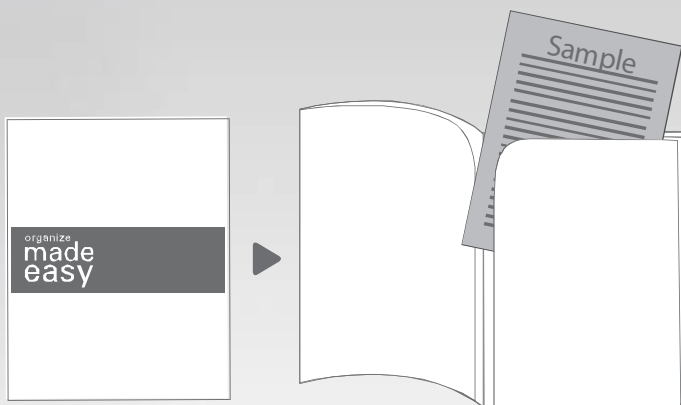



3430

| Document File |                                                    |                 |                   |
|---------------|----------------------------------------------------|-----------------|-------------------|
| Ref           | Description                                        | Unit Price (Rp) | Available Packing |
| 3430          | A4 Size/col: 07; 08; 09; 10; 11; 61; 63; 64; 65    | 20.350,-        | 1/12/144          |
| 3431          | Folio Size/col: 07; 08; 09; 10; 11; 61; 63; 64; 65 | 24.750,-        | 1/12/144          |

- Colours: 
- 15 65 64 09 63 61 21 11 07 08 10

# Document Files

## Document File

Made of strong flexible PP with 3 inside flaps and plastic locking straps.

Stopmap yang terbuat dari bahan PP yang stabil dengan 3 kumpang dalam, dan tali elastis sebagai pengunci.

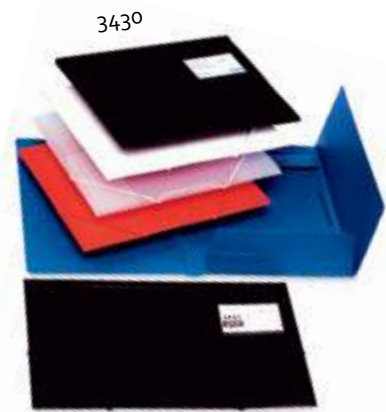

3431





# Landscape Snap Folder

## Snap Folder - Landscape

Classic way to keep your documents with different look. This landscape envelope has metallic look and come with a snap fastener closing. Suitable for FC documents.

Amplop horizontal dengan tampilan metalik dan memiliki penutup dilengkapi kancing. Produk yang umum untuk menyimpan dokumen namun dengan tampilan yang berbeda. Cocok untuk dokumen berukuran Folio

| Snap Folder Landscape |                       |                 |                   |
|-----------------------|-----------------------|-----------------|-------------------|
| Ref                   | Description           | Unit Price (Rp) | Available Packing |
| 3220 11               | Snap Folder Landscape | 11.000,-        | 1/12/120          |
| 3220 17               | Snap Folder Landscape | 11.000,-        | 1/12/120          |
| 3220 21               | Snap Folder Landscape | 11.000,-        | 1/12/120          |

Colours:



Eco friendly

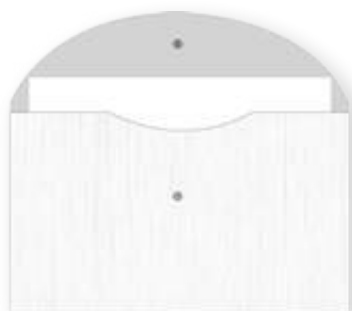

Side A



Side B



### L Folder & Snap Folder

| Ref     | Description            | Unit Price (Rp) | Available Packing |
|---------|------------------------|-----------------|-------------------|
| 2246 11 | L Folder & Snap Folder | 15.290,-        | 1/80              |
| 2246 17 | L Folder & Snap Folder | 15.290,-        | 1/80              |
| 2246 21 | L Folder & Snap Folder | 15.290,-        | 1/80              |

Colours:



# L Folder & Snap Folder

## L Folder & Snap Folder

Two ways to keep your documents in one product. One side has top and side opening. The other side an envelope folder with a snap fastener closing. This product is suitable for FC size / smaller size documents.

Satu produk dengan 2 macam fungsi penyimpanan. Satu sisi memiliki bukaan atas dan samping. Di sisi lain merupakan amplop dengan penutup dilengkapi kancing. Produk ini cocok digunakan untuk dokumen berukuran Folio atau dokumen yang lebih kecil.

# LFolder/ Letter Files



| Folder / Letter File |                                |                 |                   |
|----------------------|--------------------------------|-----------------|-------------------|
| Ref                  | Description                    | Unit Price (Rp) | Available Packing |
| 2236                 | A3 size / 0,12mm               | 10.010,-        | 1/25/100          |
| 2242                 | A4 size / 0,11mm / non skid    | 2.750,-         | 1/100/600         |
| 2245                 | Folio size / 0,11mm / non skid | 2.970,-         | 1/100/500         |
| 2245P                | Folio size / 0,11mm / non skid | 29.700,-        | 10/100/500        |

Keep actual letter/document with top and side opening made from transparent PP material. Available in assorted colour.

Folder plastik dengan permukaan transparan untuk menyimpan surat-surat atau dokumen aktual. Terbuat dari bahan PP dengan beberapa pilihan warna.

Colours: Eco friendly

# Document Wallet PP



| Document Wallet - PP |             |                 |                   |
|----------------------|-------------|-----------------|-------------------|
| Ref                  | Description | Unit Price (Rp) | Available Packing |
| 3610                 | A4 Size     | 79.530,-        | 1/10/20           |

A4 Document Wallet transparent material, available in different colours. Equipped with elastic locking straps.

Document Wallet dengan ukuran A4 dengan material transparan, tersedia dalam berbagai warna pilihan, dilengkapi dengan tali pengikat elastis.

Colours:





# Cardboard Document File A4 / Foolscap

Made of strong exclusive laminated cardboard in modern colour with elastic locking straps.

Stopmap yang terbuat dari karton tebal dilaminasi dan terkesan eksklusif dalam aneka warna. Sangat cocok untuk seminar yang menyimpan dokumen penting. Dilengkapi tali pengunci elastis.



## Cardboard Document File A4 / Foolscap

| Ref  | Description      | Unit Price (Rp) | Available Packing |
|------|------------------|-----------------|-------------------|
| 3450 | A4 size          | 11.110,-        | 1/100             |
| 3451 | Folio size       | 11.440,-        | 1/100             |
| 3455 | Folio - 03 Batik | 10.230,-        | 1/100             |

Colours:      
01 11 09 10



# Stitching Artist Portfolio Cases



Zipper in Artist Portfolio  
8003, 8005, 8006



Clip in Artist Portfolio  
8007, 8008, 8009



## Stitching Artist Portfolio Cases

| Ref  | Description               | Unit Price (Rp) | Avail. Packing |
|------|---------------------------|-----------------|----------------|
| 8003 | Artist Portfolio A3 size  | 359.150,-       | 1/4/12         |
| 8005 | Artist Portfolio A2 size  | 416.020,-       | 1/3/6          |
| 8006 | Artist Portfolio A1 size  | 559.790,-       | 1/3/6          |
| 8007 | Artist PortFolio Cases A1 | 358.490,-       | 1/3/6          |
| 8008 | Artist PortFolio Cases A2 | 217.800,-       | 1/3/6          |
| 8009 | Artist PortFolio Cases A3 | 130.900,-       | 1/3/6          |

### Stitching Artist Portfolio Cases

Protecting your Artwork and drawing against dust, humidity and lights. Available in A sizes, A1, A2, and A3. Easy to carry.

Melindungi dokumen dan hasil karya anda dari debu, kelembapan dan sinar matahari. Tersedia untuk ukuran A, seperti: A1, A2, dan A3. Mudah dan sangat praktis dibawa.

### Ink Jet Photo Paper

| Ref     | Description                | Unit Price (Rp) | Available Packing |
|---------|----------------------------|-----------------|-------------------|
| 8001-02 | A4 Glossy 10 sheets 180gr  | 53.570,-        | 1*                |
| 8001-03 | A3 Premium 10 sheets 225gr | 157.850,-       | 1*                |
| 8001-04 | A4 Premium 10 sheets 225gr | 77.770,-        | 1*                |

# Ink Jet Photo Papers

## Ink Jet Photo Paper

White opaque glossy coated true photo paper. Instant drying time. Ideally suited for printing digital photographic images. 10 sheets per pack with choice of 180 gr or 225 gr. Available in A4 and A3 size.

Kertas untuk mencetak photo atau gambar digital. Dapat dicetak dengan printer ink jet warna. Tersedia dalam kemasan 180 gr dan 225 gr, dengan ukuran kertas A4 dan A3.

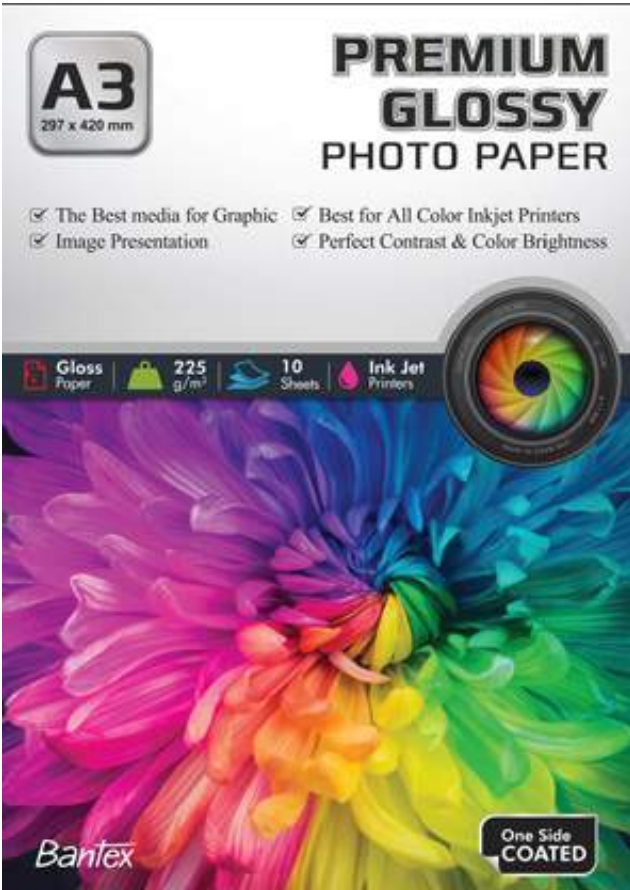

8001-03 (A3 Premium 10 sheets)



8001-04



8001-02

### Matt Coated Ink Jet Paper

| Ref     | Description         | Unit Price (Rp) | Available Packing |
|---------|---------------------|-----------------|-------------------|
| 8001-00 | A4 - 30 sheets 95gr | 63.360,-        | 1*                |
| 8001-01 | A4 - 60 sheets 95gr | 117.590,-       | 1*                |

## Matt Coated Ink Jet Paper

Bantex special formulated paper for full color inkjet print. Suitable for all ink jet printers. For high resolution color printing. One side coated 95 gr.

Kertas spesial dari Bantex yang ideal digunakan untuk ink jet printer. Cocok untuk semua jenis ink jet printers. Untuk mendapatkan hasil cetak berwarna dengan resolusi tinggi. Tersedia ukuran A4, 95 gr.



8001-00 (30 sheets)

8001-01 (60 sheets)



# Flexi Notes

| Flexi Notes |                          |                 |                |
|-------------|--------------------------|-----------------|----------------|
| Ref         | Description              | Unit Price (Rp) | Avail. Packing |
| 8871 00     | 40 x 50 mm / 100 sheets  | 4.730,-         | 1/60           |
| 8871 01     | 75 x 75 mm / 100 sheets  | 9.350,-         | 1/40           |
| 8871 02     | 125 x 75 mm / 100 sheets | 16.390,-        | 1/24           |
| 8871 03     | 50 x 75 mm / 100 sheets  | 6.820,-         | 1/40           |
| 8871 04     | 100 x 75 mm / 100 sheets | 12.100,-        | 1/30           |

## Flexi Notes

Available 5 different sizes, to fit your office needs.  
Re-useable, easy and strong.

Tersedia dalam 5 ukuran yang berbeda, untuk keperluan anda dikantor. Mudah dan dapat digunakan pada segala tempat.

Size comparison with a pen



125 x 75 mm

100 x 75 mm

75 x 75 mm

50 x 75 mm

40 x 50 mm

### Memo Glass

| Ref     | Description                       | Unit Price (Rp) | Available Packing |
|---------|-----------------------------------|-----------------|-------------------|
| 8870 02 | 75x75mm / 30 sheets / transparent | 40.920,-        | 1/50/500          |



Colours:  08

# Memo Glass

Memo with excellent transparency, easy to leave message and mark on report, documents or books. Suitable for photocopy or fax. Easily removable and reposition.

Memo transparan dengan lem non permanen, mudah dipindahkan tanpa merusak dokumen. Praktis untuk meninggalkan pesan pada laporan, dokumen atau buku. Cocok untuk dokumen, fax atau photocopy.



### Flexy Tabs

| Ref     | Description                          | Unit Price (Rp) | Available Packing |
|---------|--------------------------------------|-----------------|-------------------|
| 8870 00 | Flexi Tab 5 Neon Colour / 12 x 45 mm | 14.960,-        | 1/60/2160         |
| 8870 01 | Flexi Tab 3 Neon Colour / 20 x 45 mm | 15.620,-        | 1/60/2160         |

# Flexy Tabs

Good Quality for writability and legibility. 3&5 flexi tabs comes with bright neon colour. Noticeable from anywhere. Easy to use and repositionable glove, best for notes management.

Flexi tab dengan 3 (tiga) & 5 (lima) warna neon yang sangat mudah ditulisi. Memiliki perekat non permanen, cocok digunakan untuk memo dan catatan kecil, sebagai penanda di majalah, katalog, dan sebagai pembatas buku.



8870 00

BANTEX  
**TACK-ALL™**



8205



### **TACK-ALL**

Removable adhesive in a form of elastic sticky gum for multiple uses. Stick non permanently to all kind of material like paper, plastic and holding them to any kind of surface, and wall panels. Tack-All will not stain or leave marks. Can be used over and over again. \* Not suited for porous surfaces such as wallpaper.

Bantex Tack-All adalah perekat berbentuk karet lengket yang dapat dilepas-pasang dan dipakai berulang kali atau dipindah-pindahkan sesuai kebutuhan anda tanpa meninggalkan bekas dan noda. Bantex Tack-All bisa menempel pada berbagai permukaan seperti tembok, kaca, kertas, plastik, triplek, panel, logam, stainless steel, dsb. \* Tidak cocok untuk permukaan berpori.

### **TACK-ALL**

| Ref  | Description                        | Unit Price (Rp) | Available Packing |
|------|------------------------------------|-----------------|-------------------|
| 8205 | Tack-All Sticky Stuff-Precut 50 gr | 22.330,-        | 1/25/150          |



### **Beberapa fungsi & kegunaan Tack-All dalam aktivitas anda sehari-hari:**

- Memasang poster, foto, gambar, ornamen dekorasi ruangan
- Merekatkan sekrup pada ujung obeng untuk membantu anda memasang sekrup pada tempat yang sulit dijangkau
- Menempelkan telepon, kalkulator dan peralatan lainnya agar tidak bergeser dari posisinya di meja anda
- Sebagai perlengkapan prakarya & kerajinan tangan di sekolah
- Sebagai alat bantu ukur untuk menahan penggaris/meteran agar tidak bergeser/ bergeser
- BantexTack-All juga dapat menangkap debu dan digunakan untuk membersihkan keyboard, atau bagian dari peralatan anda yang berlekuh dan sulit dijangkau





### Glue Stick

| Ref     | Description      | Unit Price (Rp) | Available Packing |
|---------|------------------|-----------------|-------------------|
| 8210-00 | Glue Stick 8 gr  | 5.940,-         | 1/30              |
| 8211-00 | Glue Stick 22 gr | 13.640,-        | 1/12              |
| 8212-00 | Glue Stick 35 gr | 18.920,-        | 1/12              |

## Glue Stick

High quality glue sticks without solvents. Ideal for paper, cardboard, photos etc. Free of odour and clean to use. Dries permanently without wrinkling the paper.

Stik perekat berkualitas tinggi, tanpa pelarut, dan bersih dipakai, mengering tanpa mengkerutkan kertas. Cocok untuk kertas, karton dan photo.

### Reinforcement Ring

| Ref     | Description                                         | Unit Price (Rp) | Available Packing |
|---------|-----------------------------------------------------|-----------------|-------------------|
| 8005 00 | Reinforcement Ring - PP material / 250 pcs per pack | 13.200,-        | 1                 |

#### Reinforcement Ring

Reinforcement ring made from PP to protect or repair frequently handled documents in ring binders.

Penguat atau memperbaiki lubang perforasi pada dokumen yang mudah aus/ sobek terbuat dari bahan PP.

Colours: 

08



Eco Friendly





# Drawer Organizer

Handy for office workshop and home use. Rounded compartment for easy retrieval.

Tempat aksesoris serta alat tulis untuk dikantor anda dan dirumah. Dapat ditaruh dalam laci anda untuk memudahkan identifikasi barang.

Colours:   
10 01

| Drawer Organizer |                                          |                 |                   |
|------------------|------------------------------------------|-----------------|-------------------|
| Ref              | Description                              | Unit Price (Rp) | Available Packing |
| 9841             | Drawer 10 compartment size: 293 x 180 mm | 87.120,-        | 1/16              |
| 9842             | Drawer 7 compartment size: 325 x 240 mm  | 133.760,-       | 1/8               |



9841



9842





### Desk Organizer Opaque

| Ref     | Description           | Unit Price (Rp) | Available Packing |
|---------|-----------------------|-----------------|-------------------|
| 9830 01 | Desk Organizer Opaque | 59.180,-        | 1                 |
| 9830 08 | Desk Organizer Opaque | 59.180,-        | 1                 |
| 9830 09 | Desk Organizer Opaque | 59.180,-        | 1                 |
| 9830 10 | Desk Organizer Opaque | 59.180,-        | 1                 |

Colours:   
08 10 01 09



## Opaque Desk Organizer

### Desk Organizer Opaque

Organizer your office work with handy organizer. Keep your desk ready of all time.

Tempat alat tulis (pensil, penghapus) yang mudah digunakan untuk merapihkan meja anda. Membuat meja kerja anda selalu rapi.





### Waste Paper Basket

| Ref  | Description                        | Unit Price (Rp) | Available Packing |
|------|------------------------------------|-----------------|-------------------|
| 9820 | 17 Liter volume / plastic material | 209.660,-       | 1                 |

## Waste Paper Basket

### Waste Paper Basket

Made of the finished injection moulded plastic material.  
Bak sampah untuk kertas, terbuat dari bahan plastik.

Colours:

10

## Tape Dispenser

### Tape Dispenser

Silky surface tape dispenser with stainless steel blades, weighted and non-skid base. Available in 4 different fruit colors: Mango, Lime, Blueberry and Melon.

Tempat selotip dengan lapisan di permukaan yang halus, dilengkapi pisau stainless steel, dan pemberat sehingga tidak licin.

### Tape Dispenser

| Ref      | Description              | Unit Price (Rp) | Available Packing |
|----------|--------------------------|-----------------|-------------------|
| 18510 62 | Tape Dispenser Blueberry | 58.300,-        | 1/12/96           |
| 18510 63 | Tape Dispenser Melon     | 58.300,-        | 1/12/96           |
| 18510 64 | Tape Dispenser Mango     | 58.300,-        | 1/12/96           |
| 18510 65 | Tape Dispenser Lime      | 58.300,-        | 1/12/96           |

Colours:

65 62 63 64



Office Pencil - HB

**LINEX**

| Ref  | Description      | Unit Price (Rp) | Available Packing |
|------|------------------|-----------------|-------------------|
| 4862 | Pencil /grade HB | 50.160,-        | 12 Pcs/Box        |

Office Pencil - 2B & HB

| Ref  | Description                     | Unit Price (Rp) | Available Packing |
|------|---------------------------------|-----------------|-------------------|
| 8116 | Pencil /grade 2B (for computer) | 29.040,-        | 12 Pcs/Box        |

**Bantex Office Pencil - 2B**

High Quality 2B Bantex pencil in NATURA finished. Suitable for school & office use. 2B computer scan compatible.

Pensil Bantex 2B berkualitas untuk komputer dengan finishing NATURA. Cocok untuk penggunaan di kantor & sekolah.



# Office Pencil



**Linex Office Pencil - HB**

High Quality Linex Classic HB Pencil. Suitable for school & office use.

Pensil Linex HB berkualitas. Cocok untuk penggunaan di kantor & sekolah.

Colour Paper Clip

| Ref  | Description                | Unit Price (Rp) | Available Packing |
|------|----------------------------|-----------------|-------------------|
| 8850 | Colour Paper Clip (80 pcs) | 23.430,-        | 1 Bag             |

**Colour Paper Clip**

This paper clip made from high durable plastics, so it won't rust & stain the paper like a metal paper clip. Consist of 5 different colours & various sizes in one packaging.

Terbuat dari plastik berkualitas tinggi, sehingga tidak akan berkarat & menodai kertas. Terdiri dari beberapa 5 macam warna dan beragam ukuran dalam satu kantong kemasan.



Various Sizes



5 Different Colors

# Paper Clip





# ID - Card Holder Series



## ID Card Holder - Portrait Layout

Plastic ID Card Holder with excellent build quality. Comes in 6 bright modern colors. Available in clip & lanyard models. Suitable for schools, hotels, factories, homes, clubs, parks, stores, restaurants, hospitals, cafes, cinemas, offices, events, etc.

Tempat kartu identitas berbahan plastik berkualitas. Tersedia dalam 6 warna cerah dengan pilihan model jepit & tali. Cocok untuk penggunaan di sekolah, hotel, pabrik, asrama, toko, restoran, klub, kafe, bioskop, rumah sakit, kantor, pameran, seminar, dll.

Colours:   
11 23 19 64 65 07





8863

# ID - Card Holder Series



## ID Card Holder - Landscape Layout

Plastic ID Card Holder with excellent build quality. Comes in 5 bright modern colors. Available in clip & lanyard models. Suitable for schools, hotels, factories, homes, clubs, parks, stores, restaurants, hospitals, cafes, cinemas, offices, events, etc.

Tempat kartu identitas berbahan plastik berkualitas. Tersedia dalam 5 warna cerah dengan pilihan model jepit & tali. Cocok untuk penggunaan di sekolah, hotel, pabrik, asrama, toko, restoran, klub, kafe, bioskop, rumah sakit, kantor, pameran, seminar, dll.

Colours:       
11 23 64 65 07



8864

## ID Card Holder Series

| Ref  | Description                      | Unit Price (Rp) | Available Packing |
|------|----------------------------------|-----------------|-------------------|
| 8866 | 54 x 90 mm with Clip / Portrait  | 12.870,-        | 1/40/400          |
| 8864 | 90 x 54 mm with Clip / Landscape | 12.870,-        | 1/40/400          |
| 8865 | 54 x 90 mm Lanyard / Portrait    | 14.190,-        | 1/40/400          |
| 8863 | 90 x 54 mm Lanyard / Landscape   | 14.190,-        | 1/40/400          |

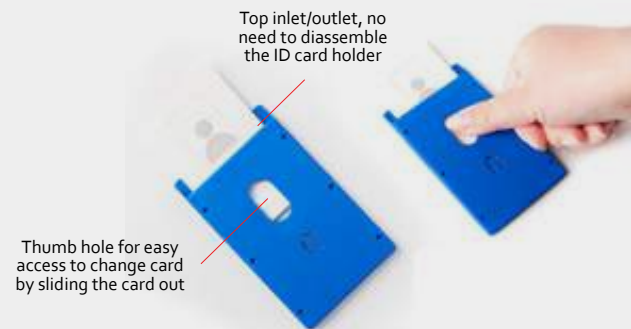

Solid built quality & material give the surface fine & smooth feeling

The design construction enables it to have enough space to store more than 1 card inside





## Staplers & Perforators

Our wide range of high quality staplers, perforators, refills & accessories products available in various sizes, colors, and models ready to suit your needs.

Lini produk stapler & perforator berkualitas kami hadir dalam beragam jenis, model dan ukuran beserta refill & aksesoris lainnya, siap untuk menjawab berbagai kebutuhan anda.



### Staplers

| Ref  | Description                 | Unit Price (Rp) | Available Packing |
|------|-----------------------------|-----------------|-------------------|
| 9340 | Small w/ Rubber Handle      | 71.830,-        | 1/6/144           |
| 9342 | Medium Size For 24/6 & 26/6 | 115.940,-       | 1/6/96            |
| 9343 | Large Size For 24/6 & 26/6  | 141.570,-       | 1/6/72            |

## Staplers

Stapler for both 24/6 and 26/6 staples. Adjusts stapling and pushing and opens fully for taking. Also available stapler with a new rubber grip (for item 9340).

Stapler kecil, setengah strip untuk staples ukuran 24/6. Untuk type 9340 juga tersedia stapler dengan pegangan terbuat dari karet.

Colours:       
11 09 10 17 07

| Chrome Stapler |                |                 |                   |
|----------------|----------------|-----------------|-------------------|
| Ref            | Description    | Unit Price (Rp) | Available Packing |
| 9331           | Stapler Chrome | 39.820,-        | 1/12/144          |

# Chrome Stapler

In blister, chrome stapler including 1 box of 1000 No. 10 staples.  
 Stapler chrome dalam blister termasuk 1 dos staples isi 1000.



| Pocket Stapler |                |                 |                   |
|----------------|----------------|-----------------|-------------------|
| Ref            | Description    | Unit Price (Rp) | Available Packing |
| 9332           | Pocket Stapler | 28.050,-        | 1/72/288          |

# Pocket Staplers

## Pocket Stapler

A light weight stapler with compact size & minimalist design, so you can carry it on your pocket with ease.

Stapler ringan dengan ukuran yang kompak & desain bentuk minimalis, memudahkan anda untuk membawanya di dalam kantong.

Size comparisson with a regular stapler



Colours:     
 11    10    19

# Staples Refills

High quality Staples thread made to the DIN - standard.  
Staples berkualitas tinggi sesuai standar DIN.



## Staples - Refill

| Ref  | Description | Unit Price (Rp) | Available Packing |
|------|-------------|-----------------|-------------------|
| 9360 | No. 10      | 3.850,-         | 1/20/1000 Box     |
| 9361 | No. 24/6    | 6.710,-         | 1/10/300 Box      |
| 9362 | No. 26/6    | 5.280,-         | 1/10/500 Box      |

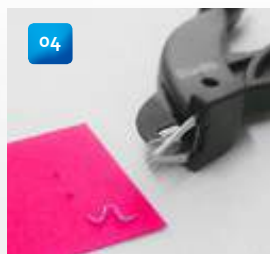
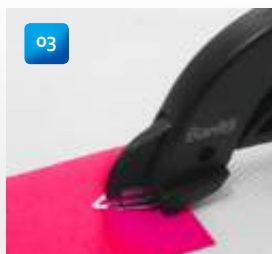
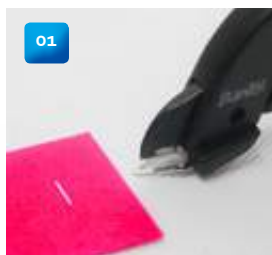

Colours:     
19 15 10

## Staple Remover 9356

| Ref  | Description                      | Unit Price (Rp) | Available Packing |
|------|----------------------------------|-----------------|-------------------|
| 9356 | Staple Remover / col: 10, 15, 19 | 30.470,-        | 1/24/360          |

### Staple Remover 9356

Modern staples remover with stylish & unique ergonomic design, enable you to remove the staples easily.

Alat pelepas staples modern dengan desain unik yang ergonomis, memungkinkan anda untuk melepaskan staples dengan mudah.







### Mini Stapler

| Ref  | Description              | Unit Price (Rp) | Available Packing |
|------|--------------------------|-----------------|-------------------|
| 9330 | Mini Stapler for Staples | 38.060,-        | 1/12/144          |

#### Mini Stapler

In blister, mini stapler including 1 box of 1000 No. 10 staples.  
 Mini stapler dalam blister termasuk 1 dos staples isi 1000.

Colours:        
 19 62 21 65 64 10



Content in the blister package



### Staple Remover 9355

| Ref  | Description              | Unit Price (Rp) | Available Packing |
|------|--------------------------|-----------------|-------------------|
| 9355 | Staple Remover / col: 10 | 11.440,-        | 1/24/600 Box      |

#### Staple Remover 9355

High quality thread made to the DIN - standard.  
 Berkualitas tinggi sesuai standar DIN.

Colours:   
 10





### Office Perforator - Small

| Ref  | Description         | Unit Price (Rp) | Available Packing |
|------|---------------------|-----------------|-------------------|
| 9300 | Perforator - 1,1 mm | 49.720,-        | 1/12/108          |

#### Office Perforator - Small

Small size metal office perforator with guide bar, 2 holes 80 mm. For 10 sheets capacity with 1.1 mm thickness.

Perforator kecil terbuat dari besi, dengan pembatas kertas untuk kantor dan rumah. 2 lubang 80 mm, kapasitas 10 lembar kertas dengan ketebalan 1,1 mm.

Colours:      
07 10 11 09



## 3-Holes & 4-Holes Perforator

For letter size paper up to 10 sheets with register for easy punching.

Perforasi 3 lubang dengan register, bisa melubangi hingga 10 lembar kertas. Tersedia perforasi 4 lubang tipe baru 9328.

### 3-Holes & 4-Holes Perforator

| Ref  | Description                   | Unit Price (Rp) | Available Packing |
|------|-------------------------------|-----------------|-------------------|
| 9328 | 4 Holes Perforator, 10 Sheets | 164.560,-       | 1/24              |
| 9329 | 3 Holes Perforator, 10 Sheets | 158.400,-       | 1/24              |

Colours:   
10



### Office Perforator - Medium

| Ref  | Description              | Unit Price (Rp) | Available Packing |
|------|--------------------------|-----------------|-------------------|
| 9303 | Office Perforator - 2 mm | 88.990,-        | 1/4/60 *          |

#### Office Perforator - Medium

Medium size perforator with guide bar 2 holes 80 mm, for 18 sheets capacity with 2 mm thickness.

Perforator kantor ukuran sedang terbuat dari besi dengan pembatas kertas 2 lubang 80 mm, untuk kapasitas 18 lembar kertas dengan ketebalan 2mm.

Colours:      
07 10 11 09



#### Office Perforator - Large

Large size perforator made from strong metal with 80 mm 2 holes distance, for 25 sheets capacity - 2.5 mm thickness. Featured with handle locker, paper waste outlet, and adjustable bar guide that can be adjusted for perforating A4, A5, A6, and 888 size paper.

Perforator ukuran besar yang terbuat dari material logam dengan 2 buah lubang berjarak 80 mm, untuk kapasitas 25 lembar - ketebalan 2,5 mm. Dilengkapi dengan pengunci handle, akses pembuangan kertas sisa, pemandu ukuran kertas yg dapat disesuaikan untuk kertas A4, A5, A6, dan 888.

Colours:     
10 11 09

### Office Perforator - Large

| Ref  | Description                | Unit Price (Rp) | Available Packing |
|------|----------------------------|-----------------|-------------------|
| 9306 | Office Perforator - 2.5 mm | 117.040,-       | 1/4/24            |

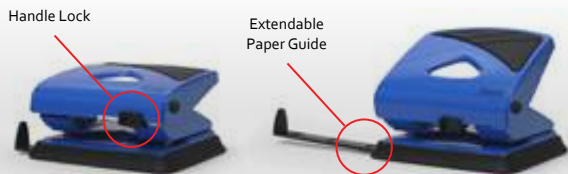



#### Paper Waste Outlet

For easy access to dispose the waste by product from your perforated paper without removing the entire base cover of the perforator.



# Bantex

Mini Perforator

Colours:    
10 11



Bantex mini punch size comparison with regular pen



| Mini Punch |                                 |                 |                   |
|------------|---------------------------------|-----------------|-------------------|
| Ref        | Description                     | Unit Price (Rp) | Available Packing |
| 9319 00    | Mini Punch / 5 sheets per punch | 23.430,-        | 1/48              |

### Mini Punch

Thin & lightweight perforator with built in ruler. Can be carried in a pencil case, in the pocket or in the mechanism of a Ring Binder or a Lever Arch File. Capacity/ punch: 5 sheets.

Perforator tipis dan ringan sekaligus penggaris yang bisa masuk ke kotak pensil, kantong atau ditaruh pada mekanik Ring Binder dan Ordner. Kapasitas kertas dalam 1x punch: 5 lembar.

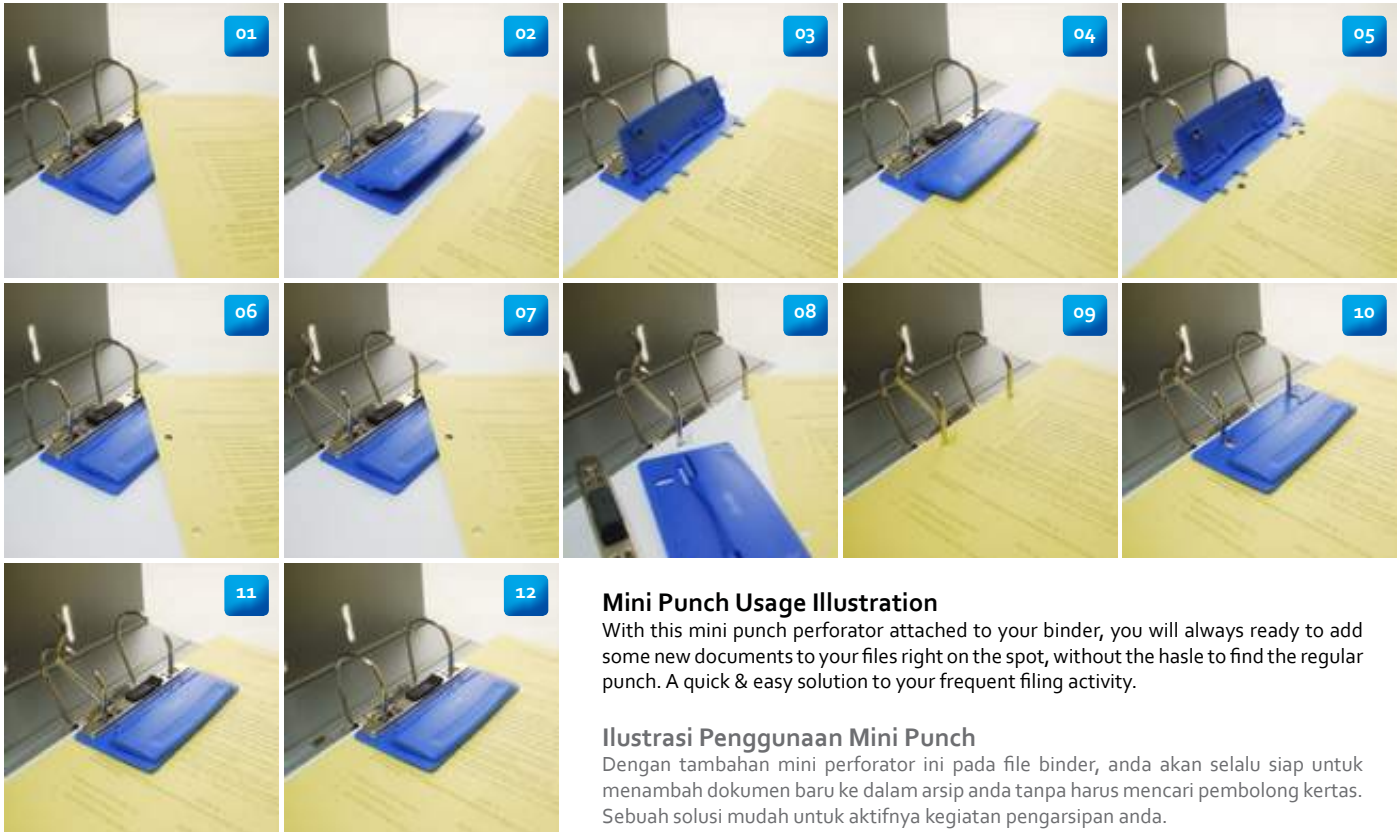

### Mini Punch Usage Illustration

With this mini punch perforator attached to your binder, you will always ready to add some new documents to your files right on the spot, without the hassle to find the regular punch. A quick & easy solution to your frequent filing activity.

### Ilustrasi Penggunaan Mini Punch

Dengan tambahan mini perforator ini pada file binder, anda akan selalu siap untuk menambah dokumen baru ke dalam arsip anda tanpa harus mencari pembolong kertas. Sebuah solusi mudah untuk aktifitas kegiatan pengarsipan anda.



## Glasstique Desk Accesories

This set made of green tint transparent acrylic with stylish and modern design. Comes with different shapes and function as desk organizer, memo holder, pencil cup, document tray, paper clip holder and also magazine file both A4, and Folio sizes.

Terbuat dari akrilik dengan kualitas yang baik dengan model dan desain yang sangat modern. Tersedia dalam berbagai bentuk dan untuk fungsi kantor yang berbeda seperti: Desk organizer, tempat memo, tempat pensil, tempat majalah dan tempat paper clip.

| Glasstique Desk Accesories |                                  | deflect-o®      |                |
|----------------------------|----------------------------------|-----------------|----------------|
| Ref                        | Description                      | Unit Price (Rp) | Avail. Packing |
| 41090                      | Glasstique Desk Organizer        | 314.820,-       | 1              |
| 41390                      | Glasstique Memo Holder           | 87.670,-        | 1              |
| 41490                      | Glasstique Pencil Cup            | 118.910,-       | 1              |
| 41990                      | Glasstique Magazine File A4 / FC | 259.600,-       | 1              |
| 542190                     | Glasstique Paper Clip Holder     | 33.880,-        | 1              |

# Stand Up & Slanted Sign Holders



Colours:  o8



## Stand up & Slanted Sign Holders

Holding signs, menu card or information sheets. Made of acrylic and transparent. Available in straight stand or slanted. Best used in Bank, seminars, receptions, restaurants.

Tempat untuk menampilkan informasi, petunjuk tanda, dengan posisi tegak atau miring. Cocok untuk digunakan di Bank, Restoran dan Hotel. Terbuat dari bahan akrilik yang dapat tembus pandang.

| Slanted Sign Holder |                           |                 |                   |
|---------------------|---------------------------|-----------------|-------------------|
| Ref                 | Description               | Unit Price (Rp) | Available Packing |
| 8852                | Slanted Sign Holder A4    | 86.900,-        | 1/10              |
| 8853                | Slanted Sign Holder A5    | 58.410,-        | 1/12              |
| 8856                | Slanted Name Plate Holder | 43.670,-        | 1/100             |
| 8857                | Slanted Sign Holder A8    | 14.960,-        | 1/200             |

| Stand Up Sign Holder |                           |                 |                   |
|----------------------|---------------------------|-----------------|-------------------|
| Ref                  | Description               | Unit Price (Rp) | Available Packing |
| 8854                 | Stand Up Sign Holder - A4 | 93.060,-        | 1/12              |
| 8855                 | Stand Up Sign Holder - A5 | 58.190,-        | 1/12              |



| Form Up |                  |                 |                   |
|---------|------------------|-----------------|-------------------|
| Ref     | Description      | Unit Price (Rp) | Available Packing |
| 8851    | Plastic material | 15.400,-        | 1/24              |

## Form Up

Hold paper till A4 size, used for information or promotion at counters, reception desks, restaurant, Banks, promotional item. Both front and back space can be printed with logo or ads.

Alat untuk meletakkan kertas dalam posisi berdiri. Cocok digunakan sebagai tempat informasi dan promosi di counter, meja registrasi, rumah makan, bank atau produk promosi. Form up juga dapat memudahkan anda dalam kegiatan mengetik sebagai tempat meletakkan berkas yang akan disalin.

Colours:

### deflect-o® 4-Tier Multi Pocket

| Ref   | Description                       | Unit Price (Rp) | Available Packing |
|-------|-----------------------------------|-----------------|-------------------|
| 77701 | 4 Tier Multi Pocket - 1/3 A4 size | 126.610,-       | 1/3               |

#### 4-Tier Multi Pocket

4 levels display magazine in A4 and Letter Size to put on table or wall.  
Multi-Compartment Tiered Literature Holder Leaflet Size

Package Description:

Leaflet Size Literature Holder

4 Compartment

4-7/8"W x 10"H x 8"D

Features:

- Displays a variety of literature at once, while saving valuable counter space
- Perfect for use in lobbies, restaurants, libraries and more
- Countertop or wall mount



Colours: o8

### 3-Tier Multi Pocket deflect-o®

| Ref   | Description                       | Unit Price (Rp) | Available Packing |
|-------|-----------------------------------|-----------------|-------------------|
| 77301 | 3 Tier Multi Pocket - A4; LS size | 150.480,-       | 1/3               |

#### 3-Tier Multi Pocket

3 levels display magazine in A4 and Letter Size to put on table or wall.

Display untuk majalah 3 susun. Dapat ditempatkan di meja atau digantung pada dinding.

Colours: o8



### Standtall Display deflect-o®

| Ref   | Description        | Unit Price (Rp) | Available Packing |
|-------|--------------------|-----------------|-------------------|
| 55601 | Standtall - 1/3 A4 | 68.090,-        | 1/6*              |

#### Standtall Display

Wall unit in module system. One standtall can be linked and jointed together. Suitable for display in exhibition.

Sistem modul, dan satuannya dapat digabungkan menjadi satuan, sangat cocok untuk pameran.

Colours: o8





8649

8648

# Business Card Cases

## Business Card Cases

| Ref  | Description        | Unit Price (Rp) | Available Packing |
|------|--------------------|-----------------|-------------------|
| 8648 | 400 cards capacity | 137.170,-       | 1/6/48            |
| 8649 | 600 cards capacity | 157.630,-       | 1/6/36            |

Black coated Metal body with glass clear cover completed with A-Z PP index. Special designed for 55 x 90 mm cards sizes. Front and back can be extended for easy access. Available for 400 or 600 cards.

Kotak kartu nama yang terbuat dari metal berwarna hitam dan tutup plastik bening serta dilengkapi dengan index A-Z terbuat dari PP khusus untuk kartu berukuran 55 x 90 mm. Bagian depan dan belakang dapat dibuka untuk kemudahan. Tersedia untuk menyimpan 400 atau 600 kartu.



## Name Card Holder

| Ref     | Description                   | Unit Price (Rp) | Available Packing |
|---------|-------------------------------|-----------------|-------------------|
| 8652 08 | 55 x 90 mm / plastic material | 3.630,-         | 1/150             |

### Name Card Holder

Universal, transparent holder for name card up to 55 x 90 mm. Supplied with a combined clip and safety pin.

Tempat tanda pengenal, berukuran universal. Terbuat dari bahan plastik transparan dan dapat (diselipkan) kartu nama sampai ukuran 55 x 90 mm. Termasuk klip dan peniti.



Colours:  08



### Telephone & Address Book

| Ref  | Description         | Unit Price (Rp) | Available Packing |
|------|---------------------|-----------------|-------------------|
| 5591 | Telp. Address Book  | 28.600,-        | 1/18              |
| 5592 | Refill for Ref 5591 | 8.910,-         | 1/10              |

#### Telephone & Address Book

With ring mechanism and alphabetical index.

Buku telepon dan alamat dengan index abjad. Cover PVC tebal dan ring mekanik.

Colours:     
05 01 25



### Business Card Album - A4

| Ref  | Description        | Unit Price (Rp) | Available Packing |
|------|--------------------|-----------------|-------------------|
| 5599 | 400 cards capacity | 130.680,-       | 1/15              |

#### Business Card Album - A4

With ring mechanism and 20 strong business card pocket antiglare, takes 400 cards with 500 insert cards and alphabetical index.

Album kartu nama dengan ring mekanik dan 20 PP business card pocket antiglare, untuk 400 kartu nama dan tersedia 50 kartu untuk isi serta dilengkapi abjad untuk mempermudah.

Colours:     
05 01 25



### Business Card Album

| Ref  | Description        | Unit Price (Rp) | Available Packing |
|------|--------------------|-----------------|-------------------|
| 5596 | 160 cards capacity | 85.910,-        | 1/20              |

#### Business Card Album

With ring mechanism, PP business card pocket. Takes 160 cards, and 20 insert cards.

Album kartu nama dengan kantong PP, dapat memuat 160 kartu dan tersedia 20 kartu untuk isi.

Colours:     
05 01 25





### Glasstique Paper Clip/Card Holder 542190

Made of green tint transparent acrylic with stylish and modern design

Terbuat dari akrilik bening kehijauan berkualitas dengan dengan model dan desain modern.



### Business Card Holder 70101

For business card 60 x 90 mm to be used in counter, reception desk etc.

Tempat kartu nama untuk ditempatkan di meja resepsi atau counter.



### Card Dispenser 8859 08

Transparent acrylic business card dispenser. Store and keep your business card. Stylish and very modern .

Kotak akrilik transparan sebagai tempat menyimpan kartu nama yang sangat kuat dan modern.

# Card Holder & Dispenser

Colours:  o8

| Card Holder & Dispenser |                             |                 |                   |
|-------------------------|-----------------------------|-----------------|-------------------|
| Ref                     | Description                 | Unit Price (Rp) | Available Packing |
| 8859 08                 | Business Card Dispenser     | 86.130,-        | 1                 |
| 70101                   | 60x90 mm Card Holder        | 13.750,-        | 1/100             |
| 542190                  | Glasstique Clip/Card Holder | 33.880,-        | 1                 |



Colours:  o8

| Memo Cube & Refill |                             |                 |                   |
|--------------------|-----------------------------|-----------------|-------------------|
| Ref                | Description                 | Unit Price (Rp) | Available Packing |
| 9750 07            | Memo 1/2 Cube White 80 gr   | 33.880,-        | 1                 |
| 9751 07            | Memo Cube White 80 gr       | 57.750,-        | 1                 |
| P352 07            | Papeo Paper Refill Memo 1/2 | 13.200,-        | 1/1               |
| P353 07            | Paper Refill Memo - Full    | 26.070,-        | 1/1               |

### Memo Cube & Refill

Memo cube with acrylic, easy use for daily office memos and notes. Memo cube yang berisi kertas untuk memo dan catatan.



| Tissue Dispenser |                         |                 |                   |
|------------------|-------------------------|-----------------|-------------------|
| Ref              | Description             | Unit Price (Rp) | Available Packing |
| 8858 o8          | Bantex Tissue Dispenser | 198.660,-       | 1                 |

Colours:  o8

## Tissue Dispenser

Transparent acrylic tissue dispenser. Made of a transparent acrylic. Stylish and very modern.

Kotak akrilik transparan sebagai tempat menyimpan tissue yang sangat kuat dan modern. Kotak tempat menyimpan tissue yang transparan, terbuat dari akrilik.

| Memo Cube Acrylic |                           |                 |                   |
|-------------------|---------------------------|-----------------|-------------------|
| Ref               | Description               | Unit Price (Rp) | Available Packing |
| 8860 o8           | Memo 1/2 Cube White 80 gr | 108.240,-       | 1                 |
| 8861 o8           | Memo Cube White 80 gr     | 176.330,-       | 1                 |

### Memo Cube Acrylic

Memo box made of transparent see through acrylic. Comes with memo notes of writing paper.

Kotak tempat memo terbuat dari bahan akrilik yang tembus pandang. Tersedia refill kertas putih.





## FANCY STRIPES STATIONERY SETS



| Fancy Stripes Series |                                   |                 |             |
|----------------------|-----------------------------------|-----------------|-------------|
| Ref                  | Description                       | Unit Price (Rp) | Avail. Pack |
| 1 8075               | Zipper Bag FC Size                | 14.850,-        | 1/12/480    |
| 2 3197               | Display Book 30 Pockets FC Size   | 64.790,-        | 1/25/100    |
| 3 3608               | Expanding File 13 Pockets FC Size | 107.140,-       | 1/15/60     |
| 4 2247               | L-Shape Folder FC Size            | 20.570,-*       | 1/120/240   |

### Fancy Stripes Series

The stationery sets from Fancy Stripes Series has the distinctive unique look from multicolor lining pattern in each of its item. Using an eco-friendly material, this series offer 5 color themes to suit your preference.

Perangkat stationery dari seri Fancy Stripes memiliki tampilan unik yang berbeda dengan corak garis multiwarna pada setiap itemnya. Terbuat dari bahan ramah lingkungan, seri ini memiliki 5 pilihan tema warna yang dapat dipilih.

Items from this series:

#### 1. Zip Folder / Bag

Folio size storage pocket with plastic zipper opening on top.

#### 2. Display Book

A bundle of 30 transparent pockets in a form of a book. Suitable for simple organizing use & easy viewing.

#### 3. Expanding File

Folder case with 13 chambers inside and handle on top. Suitable for carrying lots of documents around.

#### 4. L Shape Folder

Folder sheet divided in 3 spaces to store & cover documents

### Fancy Stripes Expanding File

Made of hard-wearing flexible PP with multicolor stripes, FC size, 13 Pockets with tabs and paper insert, with smart lock & handle on top.

Map harmonika terbuat dari bahan PP yang flexible dengan corak garis multiwarna. Ukuran FC, dilengkapi dengan 13 kantong, tab, kertas penanda, pengunci dan pegangan diatas map.



Display Book 30 Pockets FC Size



Zipper Bag FC Size

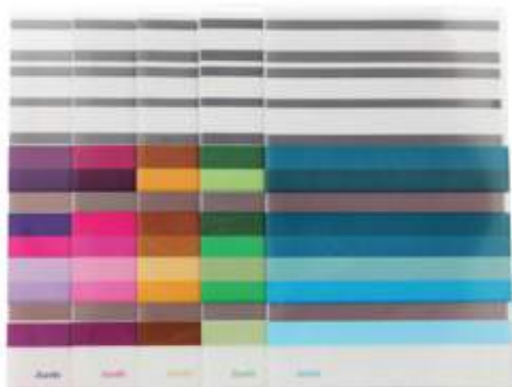

L-Shape Folder FC Size



L-Shape Folder FC Size

# Jolly Bright Stationery Sets

## Jolly Bright Series

The stationery sets from Jolly Bright Series has the distinctive unique look from the bright color themes in each of its item. Using an eco-friendly material, this series offer 4 color themes to suit your preference.

There are 4 color theme options available in Jolly Bright Series: Travel Orange, Music Pink, Cool Yellow, and Urban Green. The product range available from this series consist of: Elastic Folder, Expanding File and Document Box. Each item from the color group can be purchased separately.

Perangkat stationery dari seri Jolly Bright memiliki ciri khas unik berupa warna terang menyala pada setiap itemnya. Terbuat dari bahan ramah lingkungan, seri ini memiliki 4 pilihan tema warna yang dapat dipilih.

Terdapat 4 pilihan tema warna dalam seri Jolly Bright: Travel Orange, Music Pink, Cool Yellow, and Urban Green. Lini produk terdiri dari Elastic Folder, Expanding File and Document Box. Setiap item dari masing-masing kelompok warna dapat dibeli terpisah / secara satuan.



Elastic Folder Folio Size



Expanding File 13 Pockets FC Size



Document Box Folio Size

## Jolly Bright Series

| Ref  | Description                       | Unit Price (Rp) | Avail. Pack |
|------|-----------------------------------|-----------------|-------------|
| 3432 | Elastic Folder Folio Size         | 34.600,-        | 1/60*       |
| 3612 | Document Box Folio Size           | 69.960,-        | 1/20*       |
| 3607 | Expanding File 13 Pockets FC Size | 110.990,-       | 1/15/60*    |





The first OXFORD branded exercise books were sold in the UK in the early 30's. Today millions of OXFORD notebooks are used every year by pupils, students and business professionals. The brand has built a strong legitimacy through undisputable quality products which perfectly fit their users' needs. Today OXFORD is the leading European brand for notebooks and notepads.





**OPTIK PAPER**  
Feel the difference



# Urban Mix Notebooks



| Oxford Urban Mix Notebooks |                                      |                 |            |
|----------------------------|--------------------------------------|-----------------|------------|
| Ref                        | Description                          | Unit Price (Rp) | Avail Pack |
| 100100415                  | A5 / 100 pages / Squared / Blue      | 84.810,-        | 10/40      |
| 100101930                  | A5 / 100 pages / Ruled / Red         | 96.910,-        | 10/40      |
| 100101584                  | A4 / 100 pages / Squared / Dark Grey | 135.410,-       | 5/20       |
| 100101523                  | A4 / 100 pages / Ruled / Green       | 155.870,-       | 5/20       |
| 100105213                  | 11x17cm / 180 pages / Ruled / Blue   | 98.670,-        | 10/40      |

## Oxford Urban Mix Notebooks Series

The pioneer spirit of OXFORD is clearly expressed in this Urban Mix range of notebooks designed to keep pace with hectic urban lifestyles: Ultra-durable lightweight, virtually indestructible, waterproof notebook that can withstand extreme wear and tear without compromising on style.

Urban Mix notebook dirancang untuk mengakomodasi gaya hidup aktif di perkotaan yang sibuk: kuat, ringan & tangguh. Notebook Urban Mix hadir dengan tampilan stylish modern dengan sampul bernuansa metallic nan elegan dengan permukaan tahan air yang dapat bertahan dari koyakan & keausan dalam penggunaan ekstrim sekalipun.

- ◀ Size Comparison:  
11x17 cm (blue)  
A5 (Red)  
A4 (Green)







**OPTIK PAPER®**  
 90g/m<sup>2</sup>  
 Feel the difference

**O**PTIK PAPER® offers the incomparable experience of high definition writing. The pen nib slides smoothly across the page and your writing is perfectly neat. In all circumstances and with whatever pen you choose, OPTIK PAPER® will reproduce your writing perfectly.

With OPTIK PAPER® the ink does not bleed into the paper fibres. So you can write on both sides of the page with no show-through. Its whiteness has been calibrated to just the right level to offer the best contrast for your writing without being too bright to avoid eye strain.



OPTIK PAPER® available in ruled & squared option to suit your need.

**A4 & A5 Squared Urban Mix Notebooks**  
 Available in Blue (A5) & Dark Grey (A4), waterproof & durable cover. Detachable ruler + bookmark included.



## Urban Mix

# Urban Mix Notebooks

### Features



**Paper By Nature.** Oxford notebooks are the first paper products to be certified Paper by Nature®, the only Pan-European eco-label for converted paper products such as envelopes, notebooks and agendas.



**Detachable Ruller + Bookmark**  
 Multifunctional ruler included inside. Helps you to plot lines, as a measurement tool and at the same time functioning as a removable bookmark.



**Informative Back Cover**  
 Useful distance chart & country information in the back cover.



**Robust & Durable Cover**  
 Robust, light & durable hard-wearing cover for ultimate life-long protection.



**Waterproof Cover**  
 Waterproof hard-wearing cover with elegant metallic look.



# Essentials Notebooks

## Oxford Essential Notebooks Series

Notebook with 3-in-1 bookmark with ruler and conversion table. Practical twinwire and soft cardboard cover in stylish colours. Optical white paper, which is pleasant to write on and silky soft to the touch.

Notebook 3-in-1 dilengkapi dengan penggaris dan tabel konversi. Menggunakan optical white paper istimewa dengan ketebalan 90 gsm dan texture halus untuk kenyamanan menulis.



Ruled or Squared Paper  
High quality OPTIK PAPER® available in ruled & squared option to suit your need.

| Oxford Essentials Notebooks |                                   |                 |             |
|-----------------------------|-----------------------------------|-----------------|-------------|
| Ref                         | Description                       | Unit Price (Rp) | Avail. Pack |
| 100105406                   | A4 / 180 pages / Squared / Blue   | 171.490,-       | 5/20        |
| 100105331                   | A4 / 180 pages / Ruled / Green    | 171.490,-       | 5/20        |
| 100103741                   | A5 / 180 pages / Ruled / Blue     | 113.850,-       | 5/20        |
| 100102938                   | A5 / 180 pages / Squared / Silver | 113.850,-       | 5/20        |
| 100102931                   | A4 / 180 pages / Ruled / Black    | 171.490,-       | 5/20        |
| 100103627                   | A5 / 180 pages / Ruled / Black    | 113.850,-       | 5/20        |

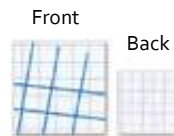

OPTIK PAPER®  
no show-through

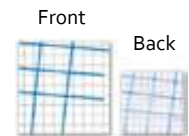

Most papers  
available on the  
market

OPTIK PAPER® offers the incomparable experience of high definition writing. The pen nib slides smoothly across the page and your writing is perfectly neat. In all circumstances and with whatever pen you choose, OPTIK PAPER® will reproduce your writing perfectly.

With OPTIK PAPER® the ink does not bleed into the paper fibres. So you can write on both sides of the page with no show-through. Its whiteness has been calibrated to just the right level to offer the best contrast for your writing without being too bright to avoid eye strain.

# Essentials Notebooks Series



8636267001

100105406

## A4 & A5 Squared Essentials Notebooks

Available in Blue (A4) & Silver (A5) Cover. Equipped with detachable ruler & bookmark. 90 sheets Optik Paper.



100105331

100102931

## A4 Ruled Essentials Notebooks

Available in Green & Black Cover. Equipped with detachable ruler & bookmark. 90 sheets Optik Paper.



100103741

100103627

## A5 Ruled Essentials Notebooks

Available in Blue & Black Cover. Equipped with detachable ruler & bookmark. 90 sheets Optik Paper.



## Essentials Notebooks Features



### Informative Back Cover

Useful distance chart & country information



### Detachable Ruler + Bookmark

Multifunctional ruler included inside. Helps you to plot lines, as a measurement tool and at the same time functioning as a removable bookmark.



### ECO Friendly Product

In 2016 OXFORD became the first brand in France and in Europe to be awarded the new EU Ecolabel for its converted paper products. The ecolabel certifies the reduced environmental impact of stationery products throughout their life cycle, from raw materials to end-of-life. The commitment includes the use of certified paper, reduced emissions to air and water, a reduced level of paper waste and energy consumption.



100% of OXFORD books and pads paper are certified FSC or PEFC to ensure our production is actively contributing in maintaining the paper cycle integrity.



**OPTIK PAPER**  
 Feel the difference



# Business Signatures Series

## Oxford Business Signatures Series

You're a creative person with lots of ideas you need to keep track of. It's important for you to have a journal close at hand to collect your thoughts, ideas or inspiration. Your journal is your best friend at work: it gives you the outlet to express yourself and to help you remember important things.

This special and very personal journal is brought to you by OXFORD and the SIGNATURE range. SIGNATURE journals lay completely flat when opened, feature premium quality paper, have sewn pages and an elastic strap to close them securely. SIGNATURE offers the complete range of features you would expect from an OXFORD notebook.

## Bright Colors Business Signatures

Available in Red, Ruby Red, Pink, and Purple colored smooth & soft surfaced polyurethane material.



**OPTIK PAPER**  
 90g/m<sup>2</sup>  
 Feel the difference

OPTIK PAPER® offers the incomparable experience of high definition writing. The pen nib slides smoothly across the page and your writing is perfectly neat. In all circumstances and with whatever pen you choose, OPTIK PAPER® will reproduce your writing perfectly.

# Business Signatures Series



**OPTIK®  
PAPER**  
90g/m<sup>2</sup>  
Feel the difference



## Dark Colors Business Signatures

Available in Grey, Brown, Blue, and Black colored soft & smooth surfaced polyurethane material.

Also available in plain paper version exclusively for black signature book



## Business Signatures

### Oxford Business Signatures Series

Notebook hard cover dengan lapisan polyurethane yang lembut sebagai media pencatat ide & inspirasi anda. Dengan kertas istimewa 90 Gsm optical white paper berpermukaan halus sehingga sangat nyaman untuk menulis. Dilengkapi pita bookmark satin, kantong penyimpanan & pen holder elastis.

| Oxford Business Signatures Series |                                     |                 |             |
|-----------------------------------|-------------------------------------|-----------------|-------------|
| Ref                               | Description                         | Unit Price (Rp) | Avail. Pack |
| Bright Colors                     |                                     |                 |             |
| 400053152                         | A5 / 144 pages / Ruled / Red        | 288.090,-       | 5/20*       |
| 400053153                         | A5 / 144 pages / Ruled / Purple     | 288.090,-       | 5/20*       |
| 400053154                         | A5 / 144 pages / Ruled / Pink       | 288.090,-       | 5/20*       |
| 400049430                         | A5 / 144 pages / Ruled / Ruby Red   | 288.090,-       | 5/20*       |
| 400045810                         | 9x14cm / 144 pages / Ruled / Purple | 182.930,-       | 5/20*       |
| Dark Colors                       |                                     |                 |             |
| 400053151                         | A5 / 144 pages / Ruled / Brown      | 288.090,-       | 5/20*       |
| 400053150                         | A5 / 144 pages / Ruled / Grey       | 288.090,-       | 5/20*       |
| 400053009                         | A5 / 144 pages / Ruled / Blue       | 288.090,-       | 5/20*       |
| 400049397                         | A5 / 144 pages / Ruled / Black      | 288.090,-       | 5/20*       |
| 400065616                         | A5 / 144 pages / Plain / Black      | 288.090,-       | 5/20*       |



Built with smooth - elegant round corner & ridge



Bookmark satin ribbon to retrieve your last page.



Flexible elastic strap closes securely your signature book.



Elastic pen loop, always keep your pen & book together



Inner pocket storage, a discreet but indeed useful pocket is glued on the back cover.



High quality casebound binding

# Signature Notebook Flex Cover



| Oxford Signature - Flex Cover Journal |                                          |                 |            |
|---------------------------------------|------------------------------------------|-----------------|------------|
| Ref                                   | Description                              | Unit Price (Rp) | Avail Pack |
| 40011221822                           | Flex cover, A5 Ruled, 80 sheet Turquoise | 352.880,-       | 5/20       |
| 40011221863                           | Flex cover, A5 Ruled, 80 sheet Melon     | 352.880,-       | 5/20       |
| 40011221819                           | Flex cover, A5 Ruled, 80 sheet Pink      | 352.880,-       | 5/20       |
| 40011221809                           | Flex cover, A5 Ruled, 80 sheet Red       | 352.880,-       | 5/20       |
| 40011221821                           | Flex cover, A5 Ruled, 80 sheet Lilac     | 352.880,-       | 5/20       |
| 40011221561                           | Flex cover, A5 Ruled, 80 sheet Grape     | 352.880,-       | 5/20       |
| 40011221501                           | Flex cover, A5 Ruled, 80 sheet Blue      | 352.880,-       | 5/20       |
| 40011221503                           | Flex cover, A5 Ruled, 80 sheet Brown     | 352.880,-       | 5/20       |
| 40011221505                           | Flex cover, A5 Ruled, 80 sheet Grey      | 352.880,-       | 5/20       |
| 40011221510                           | Flex cover, A5 Ruled, 80 sheet Black     | 352.880,-       | 5/20       |

## Oxford Signature Notebook - Flex Cover

- A5 Journal Notebook, Ruled + Margin, 160 Tamper-Proof Sewn Pages
- Extra-white and smooth gog OPTIK PAPER® to write on both sides of the page with no show-through of ink.
- Ruled pages include a header for writing a meeting or a subject title and the date and double margins for numbering points or highlighting action items.
- Lightweight flexible soft cover makes for a slimmer travel-friendly journal. Available in 10 assorted bright & classic colours.
- Compatible with the free SCRIBZEE® smartphone application to scan, save and organise your notes.
- Long-lasting textured polyurethane cover stands up to intense wear and tear.
- Flexible sewn binding lays perfectly flat when opened for comfortable writing.



Bookmark satin ribbon to retrieve your last page



Soft cover with smooth round corner



Flexible elastic strap closes book securely



Ruled Optik Paper® SCRIBZEE compatible



Flexible cover

| Oxford Signature - Hard Cover Journal |                                          |                 |            |
|---------------------------------------|------------------------------------------|-----------------|------------|
| Ref                                   | Description                              | Unit Price (Rp) | Avail Pack |
| 10073521222                           | Hard cover, A5 Ruled, 80 sheet Turquoise | 419.430,-       | 5/20       |
| 10073521263                           | Hard cover, A5 Ruled, 80 sheet Melon     | 419.430,-       | 5/20       |
| 10073521219                           | Hard cover, A5 Ruled, 80 sheet Pink      | 419.430,-       | 5/20       |
| 10073521209                           | Hard cover, A5 Ruled, 80 sheet Red       | 419.430,-       | 5/20       |
| 10073521221                           | Hard cover, A5 Ruled, 80 sheet Lilac     | 419.430,-       | 5/20       |
| 10073521061                           | Hard cover, A5 Ruled, 80 sheet Grape     | 419.430,-       | 5/20       |
| 10073521001                           | Hard cover, A5 Ruled, 80 sheet Blue      | 419.430,-       | 5/20       |
| 10073521003                           | Hard cover, A5 Ruled, 80 sheet Brown     | 419.430,-       | 5/20       |
| 10073521005                           | Hard cover, A5 Ruled, 80 sheet Grey      | 419.430,-       | 5/20       |
| 10073521010                           | Hard cover, A5 Ruled, 80 sheet Black     | 419.430,-       | 5/20       |

# Signature Notebook Hard Cover



## Oxford Signature Notebook - Hard Cover

- A5 Journal Notebook, Ruled with margin, 160 Tamper-Proof Sewn Pages
- Extra-white and smooth 90g OPTIK PAPER® to write on both sides of the page with no show-through of ink.
- Ruled pages include a header for writing a meeting or a subject title and the date and double margins for numbering points or highlighting action items.
- Flexible sewn binding lays perfectly flat when opened and the hardback cover provides a sturdy writing surface to write comfortably in all situations. OXFORD Signature journals are built to last with hard-wearing textured covers to ensure long-lasting security for your important notes.
- Compatible with the free SCRIBZEE® smartphone application to scan, save and organise your notes.
- Long-lasting textured polyurethane cover stands up to intense wear and tear.
- Flexible sewn binding lays perfectly flat when opened for comfortable writing.



Bookmark satin ribbon to retrieve your last page



Built with smooth - elegant round corner



Flexible elastic strap closes book securely



Ruled Optik Paper® SCRIBZEE compatible



Elastic pen loop, keep your pen attached



Inner pocket storage pocket on the back cover





# Black n' Red

THE MARQUE OF EXPERTISE AND EXCELLENCE

Created in England in 1964, Black n' Red offers the assurance of a professional notebook. Its unequalled quality and timeless originality make it an essential choice for demanding professionals.

Manufactured with great attention to detail and top-grade materials, Black n' Red stands out thanks to its unique design and high-quality finish. It provides a perfect blend of elegance, robustness and reliability.

These are the ideal notebooks for those who wish to combine strength and elegance. Featuring a two-sided material, black on the outside and red on the inside, the Black n' Red polypro notebook is highly resistant in any situation. It also has an elastic closure to provide greater security. 2 formats: A5 and A4.



**R**uled or  
**S**quared

High quality OPTIK PAPER® available in ruled & squared option to suit your need.

**OPTIK PAPER®** offers the incomparable experience of high definition writing. The pen nib slides smoothly across the page and your writing is perfectly neat. In all circumstances and with whatever pen you choose, OPTIK PAPER® will reproduce your writing perfectly.

With OPTIK PAPER® the ink does not bleed into the paper fibres. So you can write on both sides of the page with no show-through. Its whiteness has been calibrated to just the right level to offer the best contrast for your writing without being too bright to avoid eye strain.

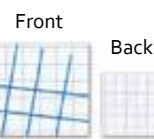

OPTIK PAPER®  
no show-through

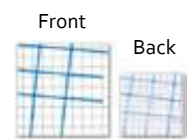

Most papers  
available on the  
market





# Black n' Red

THE MARQUE OF EXPERTISE AND EXCELLENCE



A5

A4

## Oxford Black n' Red Notebooks

The ideal notebooks for those who wish to combine strength and elegance. Featuring a two-sided material, black on the outside and red on the inside, the Black n' Red polypro notebook is highly resistant in any situation. It also has an elastic closure to provide greater security. 2 formats: A5 and A4.

Notebook yang menggabungkan kekuatan dan keanggunan. Menampilkan bahan dua sisi yang elegan, hitam di luar dan merah di bagian dalam, Cover polypropylene Black n' Red notebook sangat tahan dalam situasi apapun. Notebook ini juga dilengkapi pengunci elastis untuk memberikan keamanan ketika dibawa bepergian. Tersedia dalam 2 format: A5 dan A4.

| Oxford Black n' Red |                          |                 |                   |
|---------------------|--------------------------|-----------------|-------------------|
| Ref                 | Description              | Unit Price (Rp) | Available Packing |
| 400047655           | A5 / 140 pages / Ruled   | 219.560,-       | 5/30              |
| 400047656           | A5 / 140 pages / Squared | 170.500,-       | 5/30              |
| 400047653           | A4 / 140 pages / Ruled   | 272.030,-       | 5/20              |

in **Black n' Red**



Useful world time chart for traveling abroad



Robust, light & durable polypropylene cover for ultimate life-long protection



Water-resistant hard cover with textured textile-style outer surface



Oxford notebooks are the first paper products to be certified Paper by Nature®, the only Pan-European eco-label for converted paper products such as envelopes, notebooks and agendas.



# Black n' Red

THE MARQUE OF EXPERTISE AND EXCELLENCE



| Oxford Soft Cover Black n' Red |                                                   |                 |            |
|--------------------------------|---------------------------------------------------|-----------------|------------|
| Ref                            | Description                                       | Unit Price (Rp) | Avail Pack |
| 400051203                      | B5 Black n' Red Business Journal Soft Cover Black | 426.690,-       | 1/5/20     |
| 400051204                      | A5 Black n' Red Business Journal Soft Cover Black | 295.900,-       | 1/5/20     |

## Oxford Soft Cover Black n' Red

This business journal available in A5 & B5 size, the pages are ruled and numbered, contains 144 pages. Using high quality paper, you can write on both sides of the page with smooth white 90 gsm optik paper, providing minimal show-through of your notes

Premium soft cover on the outside. Elegant covers sewn bound for durability with an elastic closure for security. There is a rear inside pocket for storage of loose documents in the office or on the move.

Buku tulis jurnal bisnis ini tersedia dalam ukuran A5 & B5, berisi 144 halaman bergaris dan bernomor. Menggunakan kertas berkualitas tinggi yang halus dengan ketebalan istimewa 90 gsm, halaman dapat ditulis bolak balik dengan nyaman, meminimalisir tulisan tembus ke halaman sebaliknya.

Cover lunak premium yang elegan dijahit badan jurnal untuk kekuatan optimal, dilengkapi dengan strap elastis untuk keamanan. Di cover belakang terdapat kantong penyimpanan untuk dokumen dan berkas lain.



### **Oxford International Series**

Having responsibilities is what you're aiming for and you're proud of what you achieved so far. However each day presents a different challenge for you and your business which requires the best of yourself. This is why you're very demanding when choosing the tools you need to work successfully.

Especially designed for managers and executives, the OXFORD INTERNATIONAL notebook range offers innovative functionalities, higher quality and exclusive design that stands out. More than a notebook, it's the ideal business partner to have at your side.

# **Oxford International**

**S e r i e s**



**OPTIK PAPER**  
Feel the difference

# International Meetingbook



## A4 Squared Meetingbook

Squared paper meetingbook available in A4 size with dark grey cover.

| Oxford International Meetingbook |                                     |                 |            |
|----------------------------------|-------------------------------------|-----------------|------------|
| Ref                              | Description                         | Unit Price (Rp) | Avail Pack |
| 100100362                        | A4+ / 160 pages / Squared / D. Grey | 327.470,-       | 5/20       |
| 100104296                        | A4+ / 160 pages / Ruled / Orange    | 327.470,-       | 5/20       |
| 100103453                        | A5+ / 160 pages / Ruled / Orange    | 204.050,-       | 5/40       |

## Oxford International Meetingbook

2-in-1 – the perfect meeting book for people always on the move. Notebook and three-flap file integrated into one individual product. Safe storage and transport of documents, CDs and ballpoint pens with three flaps and elastic closure. The page flap can also be used as a bookmark. Practical twinwire and easy filing with microperforation and holes. Cover in light, hard-wearing and dirt-resistant polypro, plus optical white paper, which is pleasant to write on and silky soft to the touch. Useful international information about world time zones, capital cities and all international telephone codes. Special paper ruling with heading field, date field, and double margins, making it easier to organise your notes

**N**otebook untuk meeting yang sangat cocok bagi mereka yang aktif dalam rutinitas keseharian. Meetingbook merupakan kombinasi antara notebook dan document file untuk membawa dokumen yang terpisah. Dilengkapi pembatas halaman, tali pengaman elastik, cover tangguh dan kertas siap arsip untuk binder/ordner. Oxford menggunakan kertas istimewa OPTIK PAPER® dengan permukaan yang halus sehingga nyaman dan mudah untuk penulisan. Dilengkapi tabel informasi perjalanan internasional seperti zona waktu, ibukota negara dan kode telepon.

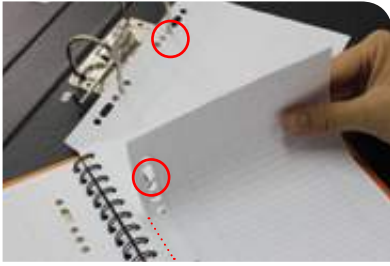

### Ordner/Binder Ready

Oxford Meetingbook has precut removable oversized perforated pages with a large 2cm stub ensure sheets tear cleanly to standard A5/A4 size for quick & easy filing in ring binders or lever arch files.



### 2 in 1 Notebook with file folder

An exclusive patented all-in-one solution including a notebook and 3-flap file. The perfect companion for well-prepared and efficient meetings.



### Flap Bookmark & Elastic Strap

Side clip flap can also serve as a bookmark. Meetingbook also provided with flexible elastic strap to give extra protection to the content of the notepad & document file.



**Extra-rigid backboard** added in the back of your note to support & ensures comfortable writing even with items stored in your back document file.



### Paper by Nature

The Paper by Nature certificate guarantees the low environmental impact from raw materials selection to the finished product.



# International Meetingbook Features

### A4 & A5 Ruled Meetingbook

Ruled paper meetingbook available in A4 & A5 size with orange cover.



### Waterproof Cover

Hard-wearing waterproof cover with elegant smooth surface give extra protection in your daily activity.



Meetingbook feature OPTIK PAPER® which offers the incomparable experience of high definition writing. Available in ruled & squared paper with special line double marks and headings for recording meetings, titles, or actions.



### Robust & Durable Cover

Robust cover made of light & durable polypropylene give you life-long protection.



Squared



Ruled



# International Activebook

## International Activebook Series

**H**ard-wearing notebook for people on the move. Practical twinwire and easy filing with microperforation and holes. Moveable tab sheet makes it easy to highlight and locate important notes or the next blank page. Simple storage of documents, CDs or business cards in the practical pocket. Cover in light, hard-wearing and dirt-resistant polypro. Optical white paper, which is pleasant to write on and silky soft to the touch. Useful international information about world time zones, capital cities and all international telephone codes. Special paper ruling with heading field, date field, and double margins, making it easier to organise your notes.

Notebook bagi mereka yang aktif dalam rutinitas keseharian, memiliki tab penanda yang mudah dipindahkan untuk menandai catatan penting. Juga terdapat kantong untuk meletakkan catatan, CD, maupun kartu nama. Oxford menggunakan Optical white Paper dengan permukaan yang halus sehingga nyaman dan mudah untuk penulisan. Dilengkapi tabel informasi perjalanan internasional seperti zona waktu, ibukota negara dan kode telepon.



### A4 & A5 Squared Activebook

Squared paper activebook available in A4 & A5 size with dark grey cover.

## Activebook Features



**Ordner/Binder Ready.** Activebook has removable oversized perforated pages with a large 2cm stub ensure sheets tear cleanly to standard A5/A4 size for quick & easy filing in ring binders or lever arch files.



**Robust & Durable Cover.** Robust, light & durable hard-wearing cover for ultimate life-long protection



**A back pocket.** Pocket in your activebook for storing additional documents/ your personal items.



**A repositionable divider** for quick & easy location of your first new page.



**Waterproof Cover.** Hard-wearing waterproof cover with elegant smooth surface give extra protection in your daily activity.



OPTIK PAPER® offers the incomparable experience of high definition writing. The pen nib slides smoothly across the page and your writing is perfectly neat.



**OPTIK<sup>®</sup>  
PAPER**   
Feel the difference



| Oxford International Activebooks |                                    |                 |            |
|----------------------------------|------------------------------------|-----------------|------------|
| Ref                              | Description                        | Unit Price (Rp) | Avail Pack |
| 100104329                        | A4+ / 160 pages / Squared / D.Grey | 243.760,-       | 5/20       |
| 100102994                        | A4+ / 160 pages / Ruled / Orange   | 243.760,-       | 5/20       |
| 100102880                        | A5+ / 160 pages / Squared / D.Grey | 158.730,-       | 5/40       |
| 100104067                        | A5+ / 160 pages / Ruled / Orange   | 158.730,-       | 5/40       |

Activebooks feature OPTIK PAPER<sup>®</sup> which offers the incomparable experience of high definition writing. The pen nib slides smoothly across the page and your writing is perfectly neat. In all circumstances and with whatever pen you choose, OPTIK PAPER<sup>®</sup> will reproduce your writing perfectly.

Its whiteness has been calibrated to just the right level to offer the best contrast for your writing without being too bright to avoid eye strain. Activebooks available in ruled & squared OPTIK PAPER<sup>®</sup> to suit your need.



Ruled paper

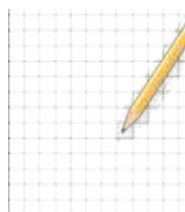

Squared paper

**OPTIK<sup>®</sup>  
PAPER**   
Feel the difference

# International Activebooks



## A4 & A5 Ruled Activebook

Ruled paper activebook available in A4 & A5 size with orange cover.

# International Activebooks with Scribzee App



| Oxford International Activebook Scribzee |                                                |                 |            |
|------------------------------------------|------------------------------------------------|-----------------|------------|
| Ref                                      | Description                                    | Unit Price (Rp) | Avail Pack |
| 400080787                                | International Activebook / Orange / B5 / Ruled | 259.930,-       | 1/5/20     |

## Oxford International Activebooks with Scribzee App

Your most valuable business partner for taking and storing notes.

Write notes in your notebook, download the app (Scribzee), scan your notes with your smartphone, save you notes directly on your smartphone or computer and share by e-mail, on OneDrive or in Dropbox.

Hard-wearing notebook for people on the move. Practical twinwire and easy filing with microperforation and holes. Moveable polypro tab sheet makes it easy to highlight and locate important notes or the next blank page. Simple storage of documents, CDs or business cards in the practical pocket. Cover in light, hard-wearing and dirt-resistant polypro.

Optical white paper, which is pleasant to write on and silky soft to the touch. Useful international information about world time zones, capital cities and all international telephone codes. Special paper ruling with heading field, date field, and double margins, making it easier to organise your notes.





| Oxford International Notepad |                          |                 |                   |
|------------------------------|--------------------------|-----------------|-------------------|
| Ref                          | Description              | Unit Price (Rp) | Available Packing |
| 1101                         | Squared Paper (5 x 5 mm) | 70.400,-        | 1/5/20 *          |
| 1102                         | Ruled Paper (8 mm)       | 70.400,-        | 1/5/20 *          |

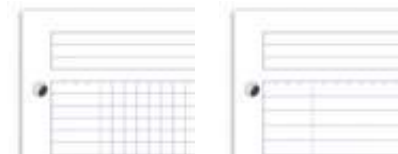

Oxford notepad features OPTIK PAPER® which offers the incomparable experience of high definition writing. Available in ruled & squared paper with special line double marks and headings for recording meetings, titles, or actions.

### Oxford International Note Pad

A4 or A5 pads of detachable sheets for filing. Convenient and Exclusive.

Buku catatan dengan ukuran A4 dan A5 yang dapat diarsip / disimpan di dalam binder. Sangat mudah digunakan dan eksklusif. Isi dalam satu buku 80 lembar memakai kertas 80 gr.



#### Ordner/Binder Ready

Practical pages with microperforations enable sheets to cleanly be torn & binder holes for easy filing in ring binders or lever arch files.



#### Informative Back Cover

Back cover contains useful information, maps and international area codes.



| Oxford Notebook Connect |                              |                 |             |
|-------------------------|------------------------------|-----------------|-------------|
| Ref                     | Description                  | Unit Price (Rp) | Avail. Pack |
| 400055726               | A4+ Size / Ruled / 160 pages | 153.670,-       | 5/20*       |

### Oxford International Notebook Connect

Notebook with solid and resistant hard cover, it allows you to write when you stand or without support. The paper is smart-ruled to optimise note-taking. Featuring detachable pre-punched sheets for easy filing and 80g High quality OPTIK PAPER®.

Buku catatan dengan cover solid yang keras, memungkinkan anda untuk mencatat sambil berdiri / tanpa alas. Menggunakan kertas istimewa OPTIK PAPER® yang telah memiliki lubang siap filing untuk dipindah ke binder / ordner.



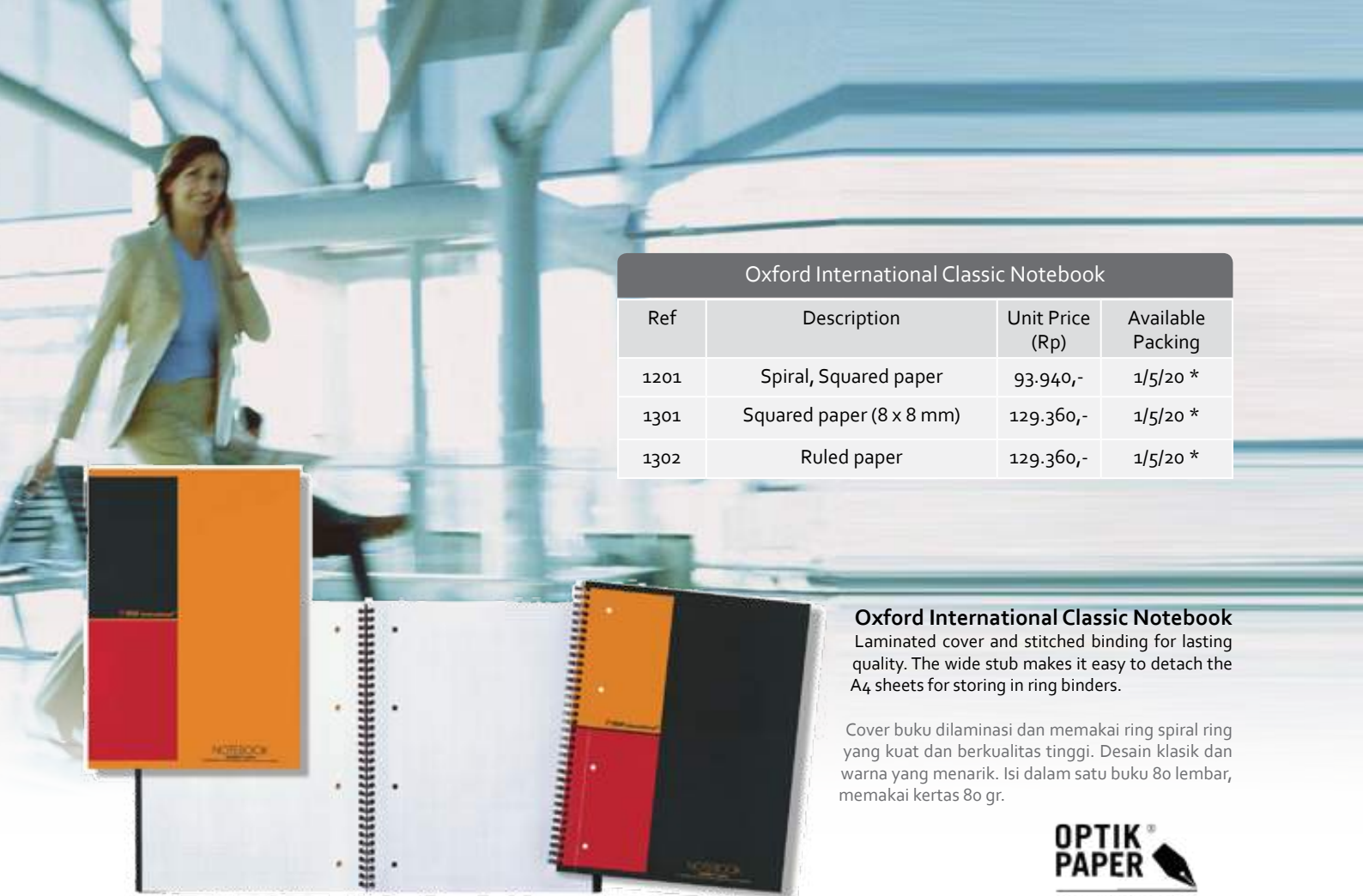

| Oxford International Classic Notebook |                          |                 |                   |
|---------------------------------------|--------------------------|-----------------|-------------------|
| Ref                                   | Description              | Unit Price (Rp) | Available Packing |
| 1201                                  | Spiral, Squared paper    | 93.940,-        | 1/5/20 *          |
| 1301                                  | Squared paper (8 x 8 mm) | 129.360,-       | 1/5/20 *          |
| 1302                                  | Ruled paper              | 129.360,-       | 1/5/20 *          |

**Oxford International Classic Notebook**

Laminated cover and stitched binding for lasting quality. The wide stub makes it easy to detach the A4 sheets for storing in ring binders.

Cover buku dilaminasi dan memakai ring spiral ring yang kuat dan berkualitas tinggi. Desain klasik dan warna yang menarik. Isi dalam satu buku 80 lembar, memakai kertas 80 gr.



# Oxford Sustainability

**PAPER BY NATURE®**

Paper by Nature® is the only eco-label able to certify all production processes for converted paper products. To be awarded this eco-label by Bureau Veritas Certification, companies must comply with a very demanding set of requirements such as the origin of the fibers in the paper, the type of inks used, the handling of emissions into the air and water or the disposal of production byproducts.

Oxford notebooks are the first paper products to be certified Paper by Nature®, the only Pan-European eco-label for converted paper products such as envelopes, notebooks and agendas.

Paper is a natural, renewable and recyclable resource. It can be recycled up to 5 times before becoming unusable. As 99% of our products are made from paper for many years OXFORD has been committed to the protection and development of forest resources by applying a responsible purchasing principle to all raw materials. The paper used in OXFORD products is sourced exclusively from wood derived from sustainably managed forests and from legal forestry operations. In 2005 OXFORD notebooks were the first to be awarded the "NF Environnement" certification. NF Environnement is a French ecolabel for notebooks and diaries that preceded the EU Ecolabel for stationery products.

100% of OXFORD books and pads paper are certified FSC or PEFC to ensure our production is actively contributing in maintaining the paper cycle integrity.



In 2016 OXFORD became the first brand in France and in Europe to be awarded the new EU Ecolabel for its converted paper products. The ecolabel certifies the reduced environmental impact of stationery products throughout their life cycle, from raw materials to end-of-life. The commitment includes the use of certified paper, reduced emissions to air and water, a reduced level of paper waste and energy consumption.

# X XYRON



**X**yron adalah merek mesin laminasi yang berdiri pada tahun 1996 di Scottsdale, Arizona – USA, yang berkembang dari ide kreatif dan akhirnya menjadi salah satu merek berkelas internasional. Xyron mengembangkan produk-produk yang berhubungan dengan kerajinan tangan, hobby dan stationery dimana pada akhirnya melahirkan produk spektakuler berupa mesin laminasi tanpa listrik dan panas yang mudah digunakan.

Mesin laminasi Xyron dapat digunakan dalam berbagai aplikasi seperti membuat stiker, membuat magnet, label dan melaminasi baik satu maupun dua sisi. Xyron telah memenangkan penghargaan di NY stationery Show pertama kalinya pada tahun 2000 sebagai "Best New Product Award" dan sampai saat ini Xyron telah memenangkan 5 penghargaan sebagai "Best New Product award" dan "Company of the year" pada beberapa event yang berbeda.

# X XYRON



## XYRON - Size A3, A4, A1

Laminating machine without heat or electricity. Laminates or sticker maker are easy. The patented quick change cartridges allow users to quickly and easily switch between applications. Comes in 3 sizes, A4, A3, and A1.

Mesin laminasi tanpa listrik dan elemen panas. Melaminasi dan membuat sticker dengan sangat mudah. Cartridge mudah diganti untuk pemakaian sesuai kebutuhan. Tersedia dalam 3 ukuran mesin yaitu A4, A3, dan A1.



Melaminasi Dokumen

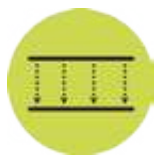

Membuat Stiker



Melaminasi dan Membuat Stiker (dokumen terlaminasi dan dapat ditempel)

## XYRON - Size A3, A4, A1

| Ref     | Model      | Description                                            | Unit Price (Rp) | Packing |
|---------|------------|--------------------------------------------------------|-----------------|---------|
| 8000 41 | DL201-100  | Two Sided Lamination                                   | 1.319.010,-     | 1       |
| 8000 43 | LAT201-50  | One Side Laminate/One Side Adhesive Transfer Permanent | 1.187.010,-     | 1       |
| 8000 45 | AT201-50   | Adhesive Transfer Permanent                            | 1.054.790,-     | 1       |
| 8000 46 | AT206-50   | Adhesive Transfer Repo                                 | 1.356.300,-     | 1       |
| 8000 47 | DL601-200  | Two Side Lamination 2x10 cm                            | 1.004.960,-     | 1*      |
| 8000 30 | XRN 1200   | Model 1200 Dispenser (A3)                              | 4.772.900,-     | 1       |
| 8000 31 | DL1101-100 | Two Sided Lamination                                   | 1.968.120,-     | 1       |
| 8000 33 | LAT1101-50 | One Side Laminate/One Side Adhesive Transfer Permanent | 1.994.520,-     | 1       |
| 8000 34 | LAT1106-50 | One Side Laminate/One Side Adhesive Transfer Repo      | 1.774.300,-     | 1*      |
| 8000 35 | AT1101-50  | Adhesive Transfer Permanent                            | 1.898.820,-     | 1       |
| 8000 36 | AT1106-50  | Adhesive Transfer Repo                                 | 1.914.000,-     | 1       |
| 8000 11 | DL403-300  | Two Sided Lamination                                   | 4.838.790,-     | 1*      |
| 8000 13 | LAT405-300 | One Side Laminate/One Side Adhesive Transfer Permanent | 7.795.810,-     | 1*      |
| 8000 15 | AT400-300  | Adhesive Transfer Permanent                            | 6.586.360,-     | 1*      |
| 8000 16 | AT406-170  | Adhesive Transfer Repo                                 | 7.661.610,-     | 1*      |

## XYRON - Pro 1250 A3

| Ref     | Model      | Description            | Unit Price (Rp) | Packing |
|---------|------------|------------------------|-----------------|---------|
| 8000M30 | XRN850B    | M.1250 Dispenser Metal | 8.541.940,-     | 1*      |
| 8000M31 | DL1201-150 | Two Sided Lamination   | 1.658.250,-     | 1*      |
| 8000M36 | AT1206-100 | Adhesive Transfer Repo | 2.009.920,-     | 1*      |

# Papeo Boxes



**P**apeo memproduksi box berkualitas tinggi. Papeo mulai dipasarkan sejak tahun 2000 sebagai produk gift box, natural box dan fancy box, dimana dapat digunakan untuk berbagai keperluan seperti untuk promosi, kotak hadiah, perhiasan, CD/VCD/DVD, dan untuk menyimpan barang-barang koleksi lainnya.

Papeo Box memiliki beraneka ragam motif dan warna yang menarik serta berbagai ukuran yang sesuai untuk keperluan anda. Papeo menerima pesanan sesuai ukuran, motif, dan warna yang anda inginkan. Papeo juga memproduksi PCB Transfer Paper.



### Fancy Box Series

Made of thick Carton in colourful glossy paper cover. Available in 8 colourfull fancy designs. Could store small collectible or valuables items .

Terbuat dari karton tebal , dengan cover kertas glossy berwarna-warni. Tersedia 8 desain cover yang fancy. Dapat menyimpan barang-barang koleksi.



### Fancy Box Series

| Ref     | Desc.    | Size               | Unit Price (Rp) | Packing |
|---------|----------|--------------------|-----------------|---------|
| 8900 01 | Shoe Box | 320 x 240 x 125 mm | 70.840,-        | 1/4     |
| 8900 02 | Shoe Box | 295 x 215 x 105 mm | 65.670,-        | 1/6     |
| 8900 03 | Shoe Box | 270 x 190 x 85 mm  | 47.190,-        | 1/9     |
| 8900 04 | Shoe Box | 135 x 190 x 85 mm  | 38.940,-        | 1/18    |
| 8900 05 | Shoe Box | 100 x 100 x 120 mm | 38.170,-        | 1/24    |
| 8900 06 | Shoe Box | 155 x 105 x 65 mm  | 27.060,-        | 1/24    |
| 8900 07 | Shoe Box | 140 x 140 x 180 mm | 45.980,-        | 1/24    |
| 8901 01 | Pass Box | 215 x 155 x 85 mm  | 59.620,-        | 1/12    |
| 8901 02 | Pass Box | 185 x 130 x 75 mm  | 45.650,-        | 1/18    |
| 8901 03 | Pass Box | 155 x 105 x 65 mm  | 40.920,-        | 1/32    |
| 8901 04 | Pass Box | 180 x 260 x 60 mm  | 63.580,-        | 1/10    |

### Pink Box Series

| Ref     | Desc.    | Size               | Unit Price (Rp) | Packing |
|---------|----------|--------------------|-----------------|---------|
| 8900 53 | Shoe Box | 270 x 190 x 85 mm  | 37.290,-        | 1/9     |
| 8900 54 | Shoe Box | 135 x 190 x 85 mm  | 30.140,-        | 1/18    |
| 8900 55 | Shoe Box | 100 x 100 x 120 mm | 30.470,-        | 1/24    |
| 8900 56 | Shoe Box | 155 x 105 x 65 mm  | 23.540,-        | 1/32    |
| 8901 51 | Pass Box | 215 x 155 x 85 mm  | 53.460,-        | 1/12    |
| 8901 52 | Pass Box | 185 x 130 x 75 mm  | 40.700,-        | 1/18    |
| 8901 53 | Pass Box | 155 x 105 x 65 mm  | 35.750,-        | 1/32    |
| 8901 54 | Pass Box | 180 x 265 x 65 mm  | 52.580,-        | 1/10    |

### Blue Box Series

| Ref     | Desc.    | Size               | Unit Price (Rp) | Packing |
|---------|----------|--------------------|-----------------|---------|
| 8900 43 | Shoe Box | 270 x 190 x 85 mm  | 37.290,-        | 1/9     |
| 8900 44 | Shoe Box | 135 x 190 x 85 mm  | 30.140,-        | 1/18    |
| 8900 45 | Shoe Box | 100 x 100 x 120 mm | 30.470,-        | 1/24    |
| 8900 46 | Shoe Box | 155 x 105 x 65 mm  | 23.540,-        | 1/32    |
| 8901 41 | Pass Box | 215 x 155 x 85 mm  | 53.460,-        | 1/12    |
| 8901 42 | Pass Box | 185 x 130 x 75 mm  | 40.700,-        | 1/18    |
| 8901 43 | Pass Box | 155 x 105 x 65 mm  | 35.750,-        | 1/32    |
| 8901 44 | Pass Box | 180 x 265 x 65 mm  | 52.580,-        | 1/10    |

### Green Box Series

| Ref     | Desc.    | Size               | Unit Price (Rp) | Packing |
|---------|----------|--------------------|-----------------|---------|
| 8900 63 | Shoe Box | 270 x 190 x 85 mm  | 37.290,-        | 1/9     |
| 8900 64 | Shoe Box | 135 x 190 x 85 mm  | 30.140,-        | 1/18    |
| 8900 65 | Shoe Box | 100 x 100 x 120 mm | 30.470,-        | 1/24    |
| 8900 66 | Shoe Box | 155 x 105 x 65 mm  | 23.540,-        | 1/32    |
| 8901 61 | Pass Box | 215 x 155 x 85 mm  | 53.460,-        | 1/12    |
| 8901 62 | Pass Box | 185 x 130 x 75 mm  | 40.700,-        | 1/18    |
| 8901 63 | Pass Box | 155 x 105 x 65 mm  | 35.750,-        | 1/32    |
| 8901 64 | Pass Box | 180 x 265 x 65 mm  | 52.580,-        | 1/10    |



### Yellow Box Series

| Ref     | Desc.    | Size               | Unit Price (Rp) | Packing |
|---------|----------|--------------------|-----------------|---------|
| 8900 73 | Shoe Box | 270 x 190 x 85 mm  | 37.290,-        | 1/9     |
| 8900 74 | Shoe Box | 135 x 190 x 85 mm  | 30.140,-        | 1/18    |
| 8900 75 | Shoe Box | 100 x 100 x 120 mm | 30.470,-        | 1/24    |
| 8900 76 | Shoe Box | 155 x 105 x 65 mm  | 23.540,-        | 1/32    |
| 8901 71 | Pass Box | 215 x 155 x 85 mm  | 53.460,-        | 1/12    |
| 8901 72 | Pass Box | 185 x 130 x 75 mm  | 40.700,-        | 1/18    |
| 8901 73 | Pass Box | 155 x 105 x 65 mm  | 35.750,-        | 1/32    |
| 8901 74 | Pass Box | 180 x 265 x 65 mm  | 52.580,-        | 1/10    |



### Purple Box Series

| Ref     | Desc.    | Size               | Unit Price (Rp) | Packing |
|---------|----------|--------------------|-----------------|---------|
| 8900 83 | Shoe Box | 270 x 190 x 85 mm  | 37.290,-        | 1/9     |
| 8900 84 | Shoe Box | 135 x 190 x 85 mm  | 30.140,-        | 1/18    |
| 8900 85 | Shoe Box | 100 x 100 x 120 mm | 30.470,-        | 1/24    |
| 8900 86 | Shoe Box | 155 x 105 x 65 mm  | 23.540,-        | 1/32    |
| 8901 81 | Pass Box | 215 x 155 x 85 mm  | 53.460,-        | 1/12    |
| 8901 82 | Pass Box | 185 x 130 x 75 mm  | 40.700,-        | 1/18    |
| 8901 83 | Pass Box | 155 x 105 x 65 mm  | 35.750,-        | 1/32    |
| 8901 84 | Pass Box | 180 x 265 x 65 mm  | 52.580,-        | 1/10    |





### Natural Box Series

| Ref     | Desc.    | Size               | Unit Price (Rp) | Packing |
|---------|----------|--------------------|-----------------|---------|
| 8900 11 | Shoe Box | 320 x 240 x 125 mm | 43.450,-        | 1/4     |
| 8900 12 | Shoe Box | 295 x 215 x 105 mm | 36.740,-        | 1/6     |
| 8900 13 | Shoe Box | 270 x 190 x 85 mm  | 32.560,-        | 1/9     |
| 8900 14 | Shoe Box | 135 x 190 x 85 mm  | 25.410,-        | 1/18    |
| 8901 11 | Pass Box | 215 x 155 x 85 mm  | 47.630,-        | 1/12    |
| 8901 12 | Pass Box | 185 x 130 x 75 mm  | 38.170,-        | 1/18    |
| 8901 13 | Pass Box | 155 x 105 x 65 mm  | 35.530,-        | 1/32    |
| 8901 14 | Pass Box | 180 x 265 x 65 mm  | 49.390,-        | 1/10    |



### Papeo Box 8904 & 8905

| Ref     | Desc.         | Size               | Unit Price (Rp) | Pack |
|---------|---------------|--------------------|-----------------|------|
| 8904 11 | Shoe Box A/17 | 320 x 240 x 125 mm | 55.000,-        | 1/4  |
| 8904 12 | Shoe Box A/17 | 295 x 215 x 105 mm | 47.630,-        | 1/6  |
| 8904 13 | Shoe Box A/17 | 270 x 190 x 85 mm  | 42.240,-        | 1/3  |
| 8904 14 | Shoe Box A/17 | 135 x 190 x 85 mm  | 30.800,-        | 1/18 |
| 8904 15 | Shoe Box A/17 | 100 x 100 x 120 mm | 29.260,-        | 1/24 |
| 8905 11 | Shoe Box B/17 | 320 x 240 x 125 mm | 61.710,-        | 1/4  |
| 8905 12 | Shoe Box B/17 | 295 x 215 x 105 mm | 54.230,-        | 1/6  |
| 8905 13 | Shoe Box B/17 | 270 x 190 x 85 mm  | 48.950,-        | 1/9  |
| 8905 14 | Shoe Box B/17 | 135 x 190 x 85 mm  | 33.880,-        | 1/18 |
| 8905 15 | Shoe Box B/17 | 100 x 100 x 120 mm | 40.150,-        | 1/24 |

#### Papeo Box 8904 & 8905

Shoe box kombinasi dengan perpaduan antara warna hitam dengan motif (atas hitam dengan bawah motif atau atas motif dengan bawah hitam). Tersedia dalam berbagai bentuk sesuai untuk kebutuhan anda. Type 8904 dan 8905 tersedia dalam 8 motif, dengan 5 ukuran.

### Elegant CD Boxes

| Ref  | Description        | Unit Price (Rp) | Avail. Packing |
|------|--------------------|-----------------|----------------|
| 8910 | CD Boxes / 25 Cd's | 71.170,-        | 1              |

Colours:       
01 04 06 09 05

#### Elegant CD Boxes

Made of strong card board and the boxes could be stockable. Capacity 25 CD's / box.

Terbuat dari karton yang kuat dan kotak dapat disusun. Kotak dengan kapasitas 25 CD.





### Star Box Series (Gold)

| Ref     | Desc.         | Size               | Unit Price (Rp) | Pack |
|---------|---------------|--------------------|-----------------|------|
| 8908 01 | Shoe Box B/17 | 320 x 240 x 125 mm | 56.540,-        | 1/4  |
| 8908 02 | Shoe Box B/17 | 295 x 215 x 105 mm | 49.280,-        | 1/6  |
| 8908 03 | Shoe Box B/17 | 270 x 190 x 85 mm  | 37.180,-        | 1/9  |
| 8908 04 | Shoe Box B/17 | 135 x 190 x 85 mm  | 29.480,-        | 1/18 |
| 8908 05 | Shoe Box B/17 | 100 x 100 x 120 mm | 27.390,-        | 1/24 |



### PCB Transfer Paper

| Ref    | Desc.                      | Unit Price (Rp) | Pack |
|--------|----------------------------|-----------------|------|
| P36100 | PCB Transfer Paper - 3 pcs | 15.730,-        | 1    |

#### PCB Transfer Paper

Printed Circuit Board transfer paper. Glossy in 180 grm paper. Could be printed with laser printer or photocopy.

Kertas untuk membuat PCB, kertas glossy dengan berat 180 gram. Dapat dicetak dengan printer laser atau mesin photocopy.



### Refill Memo Paper

| Ref     | Desc.                    | Unit Price (Rp) | Pack |
|---------|--------------------------|-----------------|------|
| P352 07 | Paper Refill Memo - Half | 13.200,-        | 1/1  |
| P353 07 | Paper Refill Memo - Full | 26.070,-        | 1/1  |

#### Refill Memo Paper

A stack of square paper (90x90mm) for memo cube refill (see memo cube specification at page 116).

Setumpuk kertas persegi berukuran 90x90mm sebagai isi ulang / refill memo cube (memo cube dapat dilihat di hlm. 116).





APLI adalah merek terkenal untuk produk-produk label yang berdiri sejak tahun 1958 di Barcelona, Spanyol. Merek APLI sendiri mulai di patenkan pada tahun 1960. Sejak tahun itu, APLI mulai mengembangkan jenis-jenis produknya menjadi adhesive label (kualitas lem terbaik) ukuran A4, label continuous form, label multimedia, dan business card. Dapat digunakan di printer inkjet, laser dan mesin fotocopy. APLI menggunakan bahan baku yang ramah lingkungan dan mendapat pengakuan atas mutu dengan standar kualitas internasional melalui ISO 9002.

APLI juga memiliki CD software gratis dan sangat memudahkan pencetakan label anda. APLI juga dapat dicetak melalui software Microsoft Office dan Nero Burning. Untuk anda yang menggunakan Internet, label APLI juga dapat dicetak langsung dari website <http://www.aplionline.com>



### White Paper Labels - Continuous Form

| Ref   | Label Across | Units  | Corner | Size (mm)    | Price (Rp)  | Packing |
|-------|--------------|--------|--------|--------------|-------------|---------|
| 00001 | 1            | 6.000  | Round  | 73,7 x 23,3  | 866.140,-   | 1 Box   |
| 00002 | 1            | 4.000  | Round  | 73,7 x 36,0  | 866.140,-   | 1 Box   |
| 00004 | 1            | 4.000  | Round  | 88,9 x 36,0  | 969.980,-   | 1 Box   |
| 00007 | 1            | 4.000  | Round  | 101,6 x 36,0 | 1.062.380,- | 1 Box   |
| 00027 | 3            | 12.000 | Round  | 101,6 x 36,0 | 2.852.740,- | 1 Box   |
| 00832 | 2            | 2.672  | Round  | 88,9 x 36,0  | 803.660,-   | 1 Box   |
| 01032 | 2            | 2.448  | Round  | 101,6 x 36,0 | 803.660,-   | 1 Box   |
| 01041 | 1            | 918    | Round  | 101,6 x 48,7 | 436.040,-   | 1 Box   |

### Continuous Form Labels Self Adhesive Continuous Form Computer Labels - Compatible with dot-matrix printer

APLI Self Adhesive Computer Continuous Form Labels are suitable to be used with any kind of dot-matrix printer. Self adhesive paper matt white 80 g/m<sup>2</sup> with permanent adhesive.

APLI computer label dengan ukuran continuous form cocok untuk segala macam printer dot-matrix. Bahan kertas putih berpelekat dengan tebal 80 g/m<sup>2</sup> dan lem yang permanen.



Ref. 00001  
73,7 x 23,3 mm

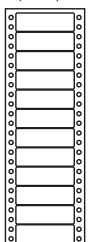

Ref. 00002  
73,7 x 36,0 mm

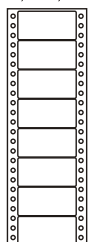

Ref. 00004  
88,9 x 36,0 mm

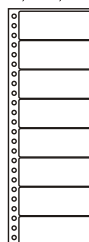

Ref. 00832  
88,9 x 36,0 mm

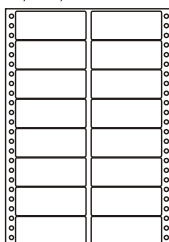

Ref. 00007  
101,6 x 36,0 mm

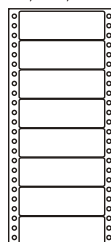

Ref. 01032  
101,6 x 36,0 mm

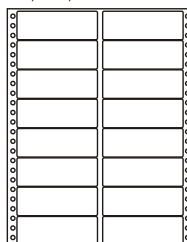

Ref. 00027  
101,6 x 36,0 mm ( 3 labels across

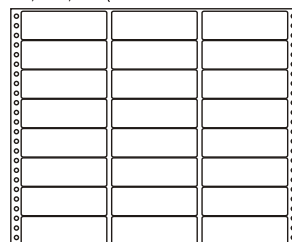

Ref. 01041  
101,6 x 48,7 mm

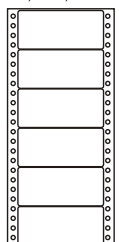

## APLI BASIC White Labels

Self Adhesive  
Compatible with inkjet, laser printer, copier



## APLI Basic - A4 Size

APLI BASIC Computer Labels are the best solution in your mailing activity. Print your customer addresses from your existing database, print symbol or company logo, and any other text and images, even barcode, as you like. It can be used in all kind of inkjet, laser printer, even copy machines.

For user convenience, we provide special software, APLI Soft Pro, which allow you to print on any size of APLI Label, with very quick and easy operational steps and very precise result. Just two clicks are enough to start working with any labels.

APLI BASIC label template also standardize available in Microsoft Office.

*APLI Computer Label merupakan solusi terbaik untuk aktivitas surat menyurat anda. Mencetak alamat pelanggan/undangan langsung dari database anda, mencetak simbol maupun logo perusahaan, teks, gambar, dan bahkan barcode sesuka anda. Dapat digunakan di semua printer inkjet, laser bahkan mesin fotokopi.*

*Untuk kenyamanan dan kemudahan anda, kami menyediakan software spesial, APLI Soft Pro (GRATIS), yang akan memungkinkan anda untuk mencetak APLI label ukuran apa saja dengan cepat dan tepat disertai panduan penggunaan yang mudah. Cukup dua klik anda siap bekerja dengan label apapun.*

*Template label APLI BASIC juga tersedia secara standar di Microsoft Office.*



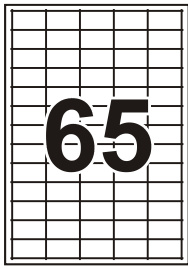

Ref. 12512  
(38 x 21,2 mm)

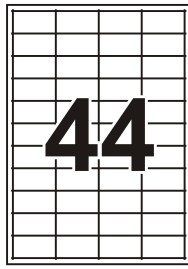

Ref. 12516  
(48,5 x 25,4 mm)

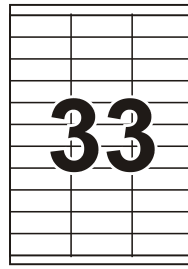

Ref. 12517  
(70 x 25,4 mm)



Ref. 02425  
(70 x 30 mm)



Ref. 02427  
(70 x 37 mm)



Ref. 02428  
(70 x 42,4 mm)



Ref. 02429  
(105 x 37 mm)



Ref. 02430  
(105 x 42,4 mm)



Ref. 02431  
(105 x 57 mm)

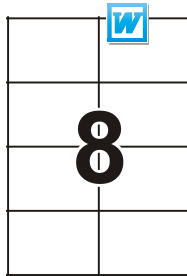

Ref. 02433  
(105 x 74 mm)



Ref. 02434  
(105 x 148 mm)



Ref. 02435  
(210 x 148 mm)

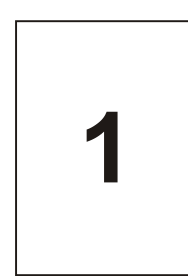

Ref. 02436  
(210 x 297 mm)

### APLI Basic (White Labels - A4 Size)

| Ref     | Unit  | Corner | Size (mm)   | Price (Rp) | Packing      |
|---------|-------|--------|-------------|------------|--------------|
| 12512   | 6.500 | Square | 38 x 21,2   | 235.950,-  | 100 sheets   |
| 12516   | 4.400 | Square | 48,5 x 25,4 | 235.950,-  | 100 sheets*  |
| 12517   | 3.300 | Square | 70 x 25,4   | 235.950,-  | 100 sheets*  |
| 02425   | 2.700 | Square | 70 x 30     | 235.950,-  | 100 sheets*  |
| 02427   | 2.400 | Square | 70 x 37     | 235.950,-  | 100 sheets*  |
| 02428   | 2.100 | Square | 70 x 42,4   | 235.950,-  | 100 sheets** |
| 02429   | 1.600 | Square | 105 x 37    | 235.950,-  | 100 sheets*  |
| 02430   | 1.400 | Square | 105 x 42,4  | 235.950,-  | 100 sheets   |
| 02431   | 1.000 | Square | 105 x 57    | 235.950,-  | 100 sheets   |
| 02433   | 800   | Square | 105 x 74    | 235.950,-  | 100 sheets** |
| 02434   | 400   | Square | 105 x 148   | 235.950,-  | 100 sheets   |
| 02435   | 200   | Square | 210 x 148   | 235.950,-  | 100 sheets   |
| 02436   | 100   | Square | 210 x 297   | 235.950,-  | 100 sheets** |
| RA02425 | 135   | Square | 70x30       | 12.760,-   | 5 sheets*    |
| RA02427 | 120   | Square | 70x37       | 12.760,-   | 5 sheets*    |
| RA02431 | 50    | Square | 105 x 57    | 12.760,-   | 5 sheets     |
| RA12512 | 325   | Square | 38 x 21,20  | 12.760,-   | 5 sheets     |

Round Corner

Square Corner

\*\* Available by request.  
MOQ: go box & kelipatannya



## A4 Computer Labels

White paper self adhesive white labels, compatible with inkjet, laser printer, and copier

APLI Self Adhesive Computer Labels are the best solution in your mailing activity. Print your customer addresses from your existing database, print symbol or company logo, and any other text and images, even barcode, as you like. It can be used in all kind of inkjet, laser printer, even copy machines.

For user convenience, we provide special software, APLI Soft Pro, which allows you to print on any size of APLI label, with very quick and easy operational steps and very precise result. Just two clicks are enough to start working with any labels.

APLI label template also standardize available in Microsoft Office.

APLI Computer Label merupakan solusi untuk masalah anda dalam pencetakan label. Mencetak alamat pelanggan dari data yang sudah ada, mencetak simbol maupun logo perusahaan, teks dan gambar, bahkan barcode sesuka anda. Dapat digunakan di semua printer inkjet, laser bahkan mesin fotokopi.

Untuk kenyamanan pemakai, kami menyediakan software khusus yaitu APLI Soft Pro, yang dapat mencetak semua ukuran dan jenis label APLI, dengan cepat dan mudah di dalam pengoperasiannya, dan dengan hasil cetak yang tepat.

Template label APLI sudah tersedia secara standar di software Microsoft Office.



Square Corner

Round Corner

### White Paper Labels - A4 Size

| Ref   | Unit | Corner | Size (mm)   | Price (Rp) | Packing    |
|-------|------|--------|-------------|------------|------------|
| 01263 | 2400 | Square | 64,6 x 33,8 | 330.880,-  | 100 sheets |
| 01264 | 200  | Square | 210 x 148   | 330.880,-  | 100 sheets |
| 01271 | 2700 | Square | 70 x 30     | 330.880,-  | 100 sheets |
| 01273 | 2400 | Square | 37 x 70     | 330.880,-  | 100 sheets |
| 01274 | 1600 | Square | 105 x 37    | 330.880,-  | 100 sheets |
| 01276 | 2100 | Square | 70 x 42,4   | 330.880,-  | 100 sheets |
| 01277 | 1400 | Square | 105 x 42,4  | 330.880,-  | 100 sheets |
| 01278 | 1000 | Square | 105 x 57    | 330.880,-  | 100 sheets |
| 01279 | 800  | Square | 105 x 74    | 330.880,-  | 100 sheets |
| 01280 | 400  | Square | 105 x 148   | 330.880,-  | 100 sheets |
| 01281 | 100  | Square | 210 x 297   | 330.880,-  | 100 sheets |
| 01282 | 6800 | Square | 48,5 x 16,9 | 330.880,-  | 100 sheets |
| 01283 | 6500 | Square | 38 x 21,2   | 330.880,-  | 100 sheets |
| 01285 | 4400 | Square | 48,5 x 25,4 | 330.880,-  | 100 sheets |
| 01286 | 4000 | Square | 52,5 x 29,7 | 330.880,-  | 100 sheets |
| 01288 | 1200 | Square | 97 x 42,4   | 330.880,-  | 100 sheets |
| 01289 | 1200 | Square | 105 x 48    | 330.880,-  | 100 sheets |
| 01292 | 800  | Square | 105 x 70    | 330.880,-  | 100 sheets |
| 01295 | 1500 | Square | 70 x 50,8   | 330.880,-  | 100 sheets |
| 02409 | 2400 | Round  | 64 x 33,9   | 330.880,-  | 100 sheets |
| 02414 | 2100 | Round  | 63,5 x 38,1 | 330.880,-  | 100 sheets |
| 02418 | 1600 | Round  | 99,1 x 34   | 330.880,-  | 100 sheets |
| 02419 | 1400 | Round  | 99,1 x 38,1 | 330.880,-  | 100 sheets |

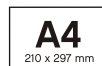

|                                                       |                                                     |                                                       |                                                     |                                                       |                                                       |                                                     |
|-------------------------------------------------------|-----------------------------------------------------|-------------------------------------------------------|-----------------------------------------------------|-------------------------------------------------------|-------------------------------------------------------|-----------------------------------------------------|
| <p>Ref. 01263 <span>100</span><br/>64,6 x 33,8 mm</p> | <p>Ref. 01271 <span>100</span><br/>70 x 30 mm</p>   | <p>Ref. 01273 <span>100</span><br/>70 x 37 mm</p>     | <p>Ref. 01274 <span>100</span><br/>105 x 37 mm</p>  | <p>Ref. 01276 <span>100</span><br/>70 x 42,4 mm</p>   | <p>Ref. 01277 <span>100</span><br/>105 x 42,4 mm</p>  | <p>Ref. 01278 <span>100</span><br/>105 x 57 mm</p>  |
| <p>Ref. 01279 <span>100</span><br/>105 x 74 mm</p>    | <p>Ref. 01281 <span>100</span><br/>210 x 297 mm</p> | <p>Ref. 01282 <span>100</span><br/>48,5 x 16,9 mm</p> | <p>Ref. 01283 <span>100</span><br/>38 x 21,2 mm</p> | <p>Ref. 01285 <span>100</span><br/>48,5 x 25,4 mm</p> | <p>Ref. 01286 <span>100</span><br/>52,5 x 29,7 mm</p> | <p>Ref. 01289 <span>100</span><br/>105 x 48 mm</p>  |
| <p>Ref. 01292 <span>100</span><br/>105 x 70 mm</p>    | <p>Ref. 2409 <span>100</span><br/>64 x 33,9 mm</p>  | <p>Ref. 02414 <span>100</span><br/>63,5 x 38,1 mm</p> | <p>Ref. 02418 <span>100</span><br/>99,1 x 34 mm</p> | <p>Ref. 02419 <span>100</span><br/>99,1 x 38,1 mm</p> | <p>Ref. 01264 <span>100</span><br/>210 X 148 mm</p>   | <p>Ref. 01280 <span>100</span><br/>105 X 148 mm</p> |

**Business Card**

| Ref   | Thickness | Units | Size (mm) | Price (Rp) | Packing   |
|-------|-----------|-------|-----------|------------|-----------|
| 10608 | 180 gr    | 100   | 90 x 50,8 | 157.960,-  | 10 sheets |

Ref. 10608  
(compatible with inkjet,  
laser printer, and copier machine)

**Business Card**

You can create your own business card with this APLI paper. Pre-cutted with standard business card size. You just need to print your own name, address, logo, and other images as you like. Using APLI Soft Pro make it easier and faster in printing.

Buat kartu nama anda sendiri dengan kertas APLI ini. Sudah terpotong sesuai dengan ukuran standar kartu nama yang biasa dipakai. Cetak nama, alamat, logo dan lain-lain sesuai dengan keperluan. Menggunakan software APLI Soft Pro membuat kerjaan menjadi mudah dan cepat.

Ref. 10608  
90 x 50,8 mm  
100 pcs / pack

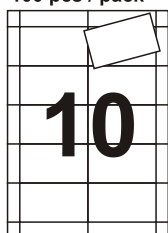

## Multimedia - CD or DVD Labels

| Ref   | Description                 | Adhesive  | Units | Diameter Size (mm)  | Price (Rp) | Packing     |
|-------|-----------------------------|-----------|-------|---------------------|------------|-------------|
| 02001 | CD ROM Label                | Removable | 50    | Out Ø 114 - In Ø 41 | 236.940,-  | 25 Sheets*  |
| 10600 | Removable Mega CD/DVD Label | Removable | 50    | Out Ø 117 - In Ø 18 | 236.940,-  | 25 Sheets*  |
| 10294 | Mega CD/DVD Label Opaque    | Permanent | 300   | Out Ø 114 - In Ø 18 | 744.700,-  | 100 Sheets* |

Ref. 02001  
Ø 114 mm

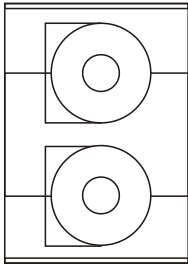

[ Removable ]

Ref. 10293  
Ø 117 mm

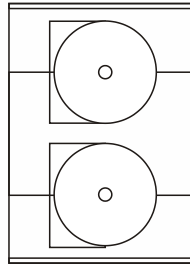

[ Glossy Inkjet ]

Ref. 10600  
Ø 117 mm

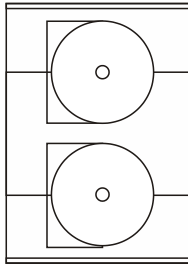

[ Removable ]

Ref. 10294  
Ø 114 mm

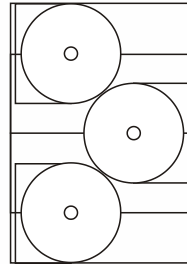

[ Opaque ]

Ref. 10396  
Ø 114 mm & 40 mm

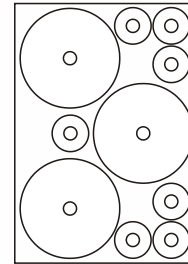

[ Opaque ]

## Multimedia

Self Adhesive Labels for CD / DVD - compatible with inkjet printer, laser printer, and copier machine

Self adhesive labels for CD or DVD cover. Design and print your own information, images, logo, etc. on APLI multimedia paper sheet. You can create your own design quick and easily with APLI Soft Pro.

Label untuk cover CD atau DVD. Desain dan cetak informasi, gambar, logo dan lain-lain di atas kertas APLI multimedia sesuai kebutuhan. Membuat desain lebih cepat dan lebih mudah dengan software APLI Soft Pro.







## Transparent Polyester / Weatherproof Label

### Self Adhesive Transparent Polyester Labels - Compatible with Laser Printer & Copier Machine

Transparent self adhesive polyester labels are ideal for using in places where long lasting labelling are needed such as outdoor using. Made of finest polyester and suitable for printing with Laserjet printer and copier machine.

Label polyester transparan cocok untuk digunakan di tempat dimana diperlukan label yang tahan lama seperti pemakaian di luar ruangan. Terbuat dari bahan yang bermutu tinggi dan dapat dicetak dengan printer laser dan mesin fotokopi.



| Transparent Polyester / Weatherproof Label |      |        |             |            |           |
|--------------------------------------------|------|--------|-------------|------------|-----------|
| Ref                                        | Unit | Corner | Size (mm)   | Price (Rp) | Packing   |
| 01223                                      | 880  | Square | 48,5 x 25,4 | 447.920,-  | 20 sheets |
| 01224                                      | 480  | Square | 70,0 x 37,0 | 447.920,-  | 20 sheets |
| 01225                                      | 20   | Square | 210 x 297   | 447.920,-  | 20 sheets |
| 10968                                      | 420  | Round  | 63,5 x 38,1 | 447.920,-  | 20 sheets |

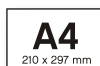

Colours: 08 (transparent)



Square Corner

Round Corner

Ref. 01223 20  
48,5 x 25,4 mm  
880 pcs / box

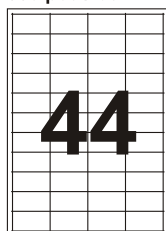

Ref. 01224 20  
70 x 37 mm  
480 pcs / box



Ref. 10968 20  
63,5 x 38,1 mm  
420 pcs / box

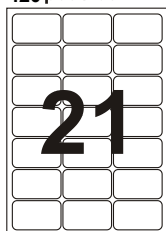

Ref. 01225 20  
210 x 297 mm  
20 pcs / box





**A4**  
210 x 297 mm

**LASER**

**COPIER**

Square  
Corner

### White Polyester / Weatherproof Labels

| Ref   | Unit | Corner | Size (mm)   | Price (Rp) | Packing   |
|-------|------|--------|-------------|------------|-----------|
| 01226 | 480  | Square | 64,6 x 33,8 | 495.990,-  | 20 sheets |

Colours:  07 (white)



Ref. 01226 20  
64,6 x 33,8 mm  
480 pcs / box



### White Polyester / Weatherproof Labels Self Adhesive Weatherproof Labels - Compatible with Laser Printer & Copier

White self adhesive labels are ideal for using in places where long lasting labelling are needed such as outdoor using. Made of finest polyester and suitable for printing with Laserjet printer and copier machine.

Label polyester putih cocok untuk digunakan di tempat dimana diperlukan label yang tahan lama seperti pemakaian di luar ruangan. Terbuat dari bahan yang bermutu tinggi dan dapat dicetak dengan printer laser dan mesin fotokopi.



### Fluorescent Yellow Promotional Label

| Ref   | Units | Shape | Size (mm) | Price (Rp) | Packing   |
|-------|-------|-------|-----------|------------|-----------|
| 10370 | 300   | Flash | Ø 35      | 183.920,-  | 20 sheets |
| 10372 | 480   | Arrow | 54,4 x 26 | 183.920,-  | 20 sheets |

Colours:  yellow

### Fluorescent Yellow Promotional Label - Flash and Arrow shape Self Adhesive Weatherproof Labels - Compatible with Laser Printer & Copier

**A4**  
210 x 297 mm

**LASER**

**COPIER**

Yellow fluorescent label for laser printer and copier with permanent adhesive. Using for highlight special items, promotions, discounts, gifts, new ideas, direction, etc. The colour that stand out a lot. The labels are pre-cutted with flash and arrow shape (no need to cut them by yourself).

Label dengan warna kuning terang dengan lem permanen. Digunakan untuk memperjelas tanda dalam promosi, pengenalan produk, diskon harga, petunjuk arah, dan lain-lain. Label sudah terpotong dalam bentuk bintang dan panah.



APLI Self Adhesive Computer Labels are the best solution in your mailing activity. Print your customer addresses from your existing database, print symbol or company logo, and any other text and images, even barcode, as you like. It can be used in all kind of inkjet, laser printer, even copy machines. Now come in economic blister packaging, to meet customers need in every occasions.

APLI Computer Label merupakan solusi untuk masalah anda dalam pencetakan label. Mencetak alamat pelanggan dari data yang sudah ada, mencetak simbol maupun logo perusahaan, teks dan gambar, bahkan barcode sesuka anda. Dapat digunakan di semua printer inkjet, laser bahkan mesin fotokopi.

Sekarang tersedia dalam kemasan ekonomis dengan jumlah lembar yang lebih sedikit, untuk memenuhi kebutuhan pemakai dalam setiap keperluan.

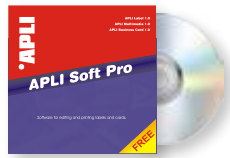

## BLISTERS PACKING Self Adhesive Continuous Form & A4 Size Labels



### White Paper Labels - A4 Size (for inkjet printer, laser printer, copier)

| Ref     | Unit | Corner | Size (mm)   | Price (Rp) | Packing  |
|---------|------|--------|-------------|------------|----------|
| RA01271 | 135  | Square | 70 x 30     | 19.030,-   | 5 sheets |
| RA01273 | 120  | Square | 37 x 70     | 19.030,-   | 5 sheets |
| RA01274 | 80   | Square | 105 x 37    | 19.030,-   | 5 sheets |
| RA01278 | 50   | Square | 105 x 57    | 19.030,-   | 5 sheets |
| RA01281 | 5    | Square | 210 x 297   | 19.030,-   | 5 sheets |
| RA01283 | 325  | Square | 38 x 21,2   | 19.030,-   | 5 sheets |
| RA01285 | 220  | Square | 48,5 x 25,4 | 19.030,-   | 5 sheets |
| RA02409 | 120  | Round  | 64 x 33,9   | 19.030,-   | 5 sheets |
| RA02414 | 105  | Round  | 63,5 x 38,1 | 19.030,-   | 5 sheets |
| RA02419 | 70   | Round  | 99,1 x 38,1 | 19.030,-   | 5 sheets |

### White Paper Labels - Continuous Form (for dot-matrix printer)

| Ref     | Label Across | Units | Corner | Size (mm)    | Price (Rp) | Packing   |
|---------|--------------|-------|--------|--------------|------------|-----------|
| RA00001 | 1            | 96    | Round  | 73,7 x 23,3  | 16.280,-   | 8 sheets  |
| RA00002 | 1            | 96    | Round  | 73,7 x 36,0  | 23.540,-   | 12 sheets |
| RA00832 | 2            | 96    | Round  | 88,9 x 36,0  | 32.450,-   | 6 sheets  |
| RA01032 | 2            | 96    | Round  | 101,6 x 36,0 | 32.450,-   | 6 sheets  |

### Polyester Labels - A4 Size (for laser printer & copier)

| Ref     | Colors      | Units | Corner | Size (mm)   | Price (Rp) | Packing  |
|---------|-------------|-------|--------|-------------|------------|----------|
| RA01224 | Transparent | 120   | Square | 70,0 x 37,0 | 117.040,-  | 5 sheets |
| RA01225 | Transparent | 5     | Square | 210 x 297   | 117.040,-  | 5 sheets |
| RA01226 | White       | 120   | Square | 64,6 x 33,8 | 129.470,-  | 5 sheets |

### Multimedia - CD/DVD (for inkjet printer, laser printer, copier)

| Ref     | Units | Diameter Size       | Price (Rp) | Packing  |
|---------|-------|---------------------|------------|----------|
| RA02001 | 10    | Out Ø 114 - In Ø 41 | 50.600,-   | 5 sheets |





Ref. 01282  
48,5 x 16,9 mm

Ref. 01285  
48,5 x 25,4 mm

Ref. 01223  
48,5 x 25,4 mm  
(Polyester Transparent)

Ref. 01286  
52,5 x 29,7 mm

Ref. 02409  
64 x 33,9 mm

Ref. 02414  
63,5 x 38,1 mm

Ref. 02419  
99,1 x 38,1 mm

Ref. 02418  
99,1 x 34 mm

Ref. 01283  
38 x 21,2 mm

Ref. 01263  
64,6 x 33,8 mm

Ref. 01226  
64,6 x 33,8 mm  
(Polyester Transparent)

Ref. 01276  
70 x 42,4 mm

Ref. 01271  
70 x 30 mm



Ref. 01274  
105 x 37 mm

Ref. 01273  
70 x 37 mm

Ref. 01224  
70 x 37 mm  
(Polyester Transparent)

105 x 74 mm Ref. 01279

105 x 70 mm Ref. 01292

105 x 57 mm Ref. 01278

Ref. 01289 105 x 48 mm

105 x 42,4 mm Ref. 01277

# Continuous Paper Label

Ref. 00001  
73,7 x 23,3 mm

Ref. 00002  
73,7 x 36,0 mm

Ref. 00832  
88,9 x 36,0 mm

Ref. 01032  
101,6 x 36,0 mm

### APLI Basic Flexy (ABF) White Labels 10 Sheets

| Ref    | Units | Corner | Size (mm) | Price (Rp) | Packing   |
|--------|-------|--------|-----------|------------|-----------|
| AF1030 | 120   | Round  | 32 X 64   | 8.690      | 10 sheets |
| AF1040 | 160   | Round  | 24 X 75   | 8.690      | 10 sheets |
| AF1120 | 1440  | Round  | 8 x 20    | 8.690      | 10 sheets |
| AF1130 | 2100  | Round  | 9 X 12    | 8.690      | 10 sheets |
| AF1070 | 300   | Square | 18 x 50   | 8.690      | 10 sheets |
| AF1090 | 550   | Round  | 13 X 38   | 8.690      | 10 sheets |
| AF1010 | 60    | Round  | 50 X 100  | 8.690      | 10 sheets |
| AF1210 | 100   | Round  | 38 x 75   | 8.690      | 10 sheets |
| AF1230 | 720   | Round  | 11 X 30   | 8.690      | 10 sheets |
| AF990  | 1160  | Round  | 5 X 34    | 8.690      | 10 sheets |



AF990

### APLI Basic Flexy (ABF)

APLI Basic Flexy (ABF) has a whiter paper label, best quality for the adhesive and anti paper jam for printer used. Handwriting label that also fits for printed in all kinds of ink jet and laser printers. The templates for ABF label is available on the website [www.aplionline.com](http://www.aplionline.com).

APLI Basic Flexy (ABF) mempunyai kertas yang lebih putih, kualitas adhesive lebih bagus dan anti nyangkut di printer. Label tulis tangan yang juga cocok bisa diprint segala macam printer ink jet dan laser. Untuk kenyamanan dan kemudahan anda. Template label APLI Basic Flexy (ABF) tersedia di website [www.aplionline.com](http://www.aplionline.com).

### APLI Basic Flexy (ABF) White Labels 5 Sheets

| Ref     | Units | Corner | Size (mm) | Price (Rp) | Packing  |
|---------|-------|--------|-----------|------------|----------|
| AF1030E | 60    | Round  | 32 x 64   | 5.060,-    | 5 sheets |
| AF990E  | 580   | Round  | 5 x 34    | 5.060,-    | 5 sheets |
| AF1210E | 50    | Round  | 38 x 75   | 5.060,-    | 5 sheets |
| AF1070E | 150   | Square | 18 x 50   | 5.060,-    | 5 sheets |
| AF1010E | 30    | Round  | 50 x 100  | 5.060,-    | 5 sheets |
| AF1120E | 720   | Round  | 8 x 20    | 5.060,-    | 5 sheets |
| AF1090E | 275   | Round  | 13 x 38   | 5.060,-    | 5 sheets |



AF1010



AF1070



AF1030



AF1230



AF1210



AF1040



AF1120

## APLI Basic Flexy (ABF)

APLI Basic Flexy (ABF) has a whiter paper label, best quality for the adhesive and anti paper jam for printer used. Handwriting label that also fits for printed in all kinds of ink jet and laser printers. The templates for ABF label is available on the website [www.aplionline.com](http://www.aplionline.com).

APLI Basic Flexy (ABF) mempunyai kertas yang lebih putih, kualitas adhesive lebih bagus dan anti nyangkut di printer. Label tulis tangan yang juga cocok bisa diprint segala macam printer ink jet dan laser. Untuk kenyamanan dan kemudahan anda. Template label APLI Basic Flexy (ABF) tersedia di website [www.aplionline.com](http://www.aplionline.com).

|                              |  |                           |                             |
|------------------------------|--|---------------------------|-----------------------------|
| <b>AF1120</b><br>8 x 20 mm   |  |                           |                             |
| <b>AF1090</b><br>13 x 38 mm  |  |                           |                             |
| <b>AF1070</b><br>18 x 50 mm  |  |                           |                             |
| <b>AF1040</b><br>24 x 75 mm  |  |                           |                             |
| <b>AF1030</b><br>32 x 64 mm  |  |                           |                             |
| <b>AF1210</b><br>38 x 75 mm  |  |                           | <b>AF1130</b><br>9 x 12 mm  |
| <b>AF1010</b><br>50 x 100 mm |  | <b>AF990</b><br>5 x 34 mm | <b>AF1230</b><br>11 x 30 mm |



3L Office Products A/S is an international production company based in Denmark. We've been designing, producing and distributing high-quality office products since 1969. Today, 3L products are now sold in more than 50 countries around the world.

3L modern headquarters and production facilities are all on one site. With R&D, manufacturing and sales and marketing located under one roof, we're able to respond rapidly to the needs of our customers, wherever they are in the world.

3L growing product range consists of over 250 items, the vast majority of which are designed and manufactured in Denmark, where innovative design, functionality and attention to detail are highly valued.

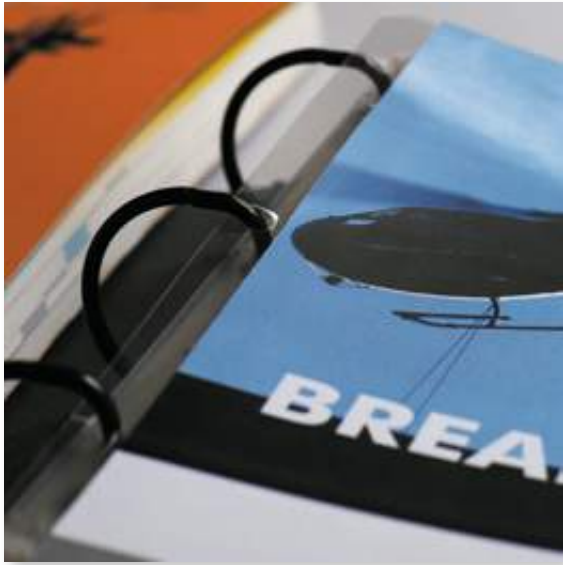

### Clip Strips

| Ref     | Description   | Quantity/<br>Pack | Size<br>(mm) | Price<br>(Rp) | Pack |
|---------|---------------|-------------------|--------------|---------------|------|
| 8808-10 | Clip-OHP Film | 10                | 295          | 27.500,-      | 1*   |
| 8808-50 | Clip-OHP Film | 50                | 295          | 88.990,-      | 1*   |



## Clip Strips

Clip Strips, special design for attaching document to binders without punching holes, made of hard strong material.

Clip Strip dirancang khusus untuk menempatkan dokumen di binder tanpa membuat lubang, terbuat dari bahan yang lebih keras dan kuat.



### Label Holders

| Ref         | Size       | Quantity/<br>Bag | Unit Price<br>(Rp) | Packing |
|-------------|------------|------------------|--------------------|---------|
| PP Material |            |                  |                    |         |
| 10305       | 19 x 75 mm | 16               | 15.400,-           | 1*      |

## Label Holders

For quick identification of binders, files, manuals, storage boxes, etc. Material clear vinyl with labels and PP.

Kantung label dari bahan Vinyl bening dan PP untuk identifikasi punggung map, file, manual, bak surat dan sebagainya.

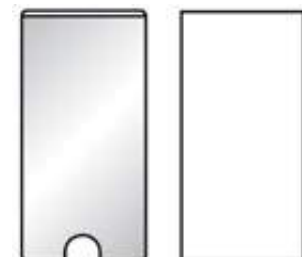



| Index Tabs  |                   |                    |
|-------------|-------------------|--------------------|
| Desc.       | 50 mm*<br>32 Tabs | 50 mm*<br>160 Tabs |
| Color       |                   |                    |
| 09- Red     |                   | Ref: 22.121        |
| 12- Orange  |                   |                    |
| 04- Green   | Ref: 22.024       | Ref: 22.124        |
| 01- Blue    | Ref: 22.025       | Ref: 22.125        |
| Price / Bag | Rp 11.880,-       | Rp 39.710,-        |



## Index Tabs

Ideal for rapid indexing. Print your title directly on the label peel and apply to computer print outs, catalogues, binders, publications and other texts. Available in 25 mm and 50 mm.

Cocok untuk membuat index secara cepat. Judul dapat langsung ditempel pada hasil cetakan komputer, katalog, binder, suatu publikasi dan teks lainnya. Tersedia dalam ukuran 25 mm dan 50 mm.

| IDTag  |                      |                  |                    |         |
|--------|----------------------|------------------|--------------------|---------|
| Ref    | Description          | Quantity/<br>Bag | Unit<br>Price (Rp) | Packing |
| 11134  | PP ID Tag excl. Clip | 1 Pcs            | 3.740,-            | 1       |
| 7456-1 | Clip for ID Tag      | 1 Pcs            | 7.810,-            | 1       |

## IDTag

ID tags deliver with labels clip that will leave no marks on cloth. For ID card ideal for company security, control and name badge at exhibition. Max card size, 58 x 92 mm.

ID tag lengkap dengan penjepit yang tidak merusak pakaian, sangat cocok dipakai untuk kartu pengenalan perusahaan atau pameran. Ukuran kartu maksimum 58 x 92 mm.



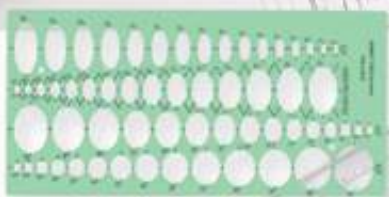

# **LINEX**

In 1923, a Danish civil engineering student, Frede Duelund Nielsen, started manufacturing ship curves. Over the years, he expanded his product line with set squares and rulers; finally, LINEX A/S was formally established in 1935. Exports started in 1936 and grew steadily. After World War II, sales and exports increased dramatically and the company expanded rapidly as Linex became known as one of the leading brands of drawing articles in the world. Today, Linex is still focused on manufacturing and trading a wide range of high-quality drawing articles. When you're using Linex-products you can be sure of precision, irrespective of being an engineer, an architect, a student or any other user.

Art Knives and Cutting Knives

| Ref  | Description                      | QTY/<br>Set | Unit Price<br>(Rp) | Avail.<br>Packing |
|------|----------------------------------|-------------|--------------------|-------------------|
| 4686 | CK 1100 Hobby Knife w/ Magazine  | 1           | 116.710,-          | 1                 |
| 4800 | Art Knife CK 100 4mm (blade)     | 1           | 103.400,-          | 1                 |
| 4801 | Art Knife CK 200 8mm (blade)     | 1           | 109.450,-          | 1                 |
| 4829 | CK-400 Small Hobby Knife         | 1           | 12.540,-           | 1                 |
| 4830 | CK-500 Large Hobby Knife         | 1           | 39.490,-           | 1                 |
| 4953 | CK 900 Hobby Knife - Rubber Grip | 1           | 74.030,-           | 1                 |

# Art Knives & Cutting Knives



Sample retail packaging (blister packing)

### Art Knives and Cutting Knives

High quality stable cutting knife, solid material non slip holder and good handling, ideal to cut curve. Spare knives available. Also available rotary cutter and office scissors.

Pisau potong yang stabil, batang metal anti slip dan mantap di tangan, cocok untuk memotong kurva. Tersedia pisau cadangan.



4953

#### CK 900 Hobby Knife

Extra strong construction with screw-lock and 0.8 mm thick blade. Rubberized, ergonomic handle provides secure grip. Blister-packed.



4830

#### CK 500 Hobby Knife

Large hobby knife, snap-off type, with metal reinforcement. Blister-packed.

# Art Knives & Cutting Knives



Sample retail packaging (blister packing)

### CK 1100 Hobby Knife

Larger version of CK 1000 with the same features. The built-in magazine contains 5 extra blades. Blister-packed.

### CK 400 Hobby Knife

Small hobby knife, snap-off type. Blister-packed.

| Art Knives and Cutting Knives |                                  |          |                 |                |
|-------------------------------|----------------------------------|----------|-----------------|----------------|
| Ref                           | Description                      | QTY/ Set | Unit Price (Rp) | Avail. Packing |
| 4686                          | CK 1100 Hobby Knife w/ Magazine  | 1        | 116.710,-       | 1              |
| 4800                          | Art Knife CK 100 4mm (blade)     | 1        | 103.400,-       | 1              |
| 4801                          | Art Knife CK 200 8mm (blade)     | 1        | 109.450,-       | 1              |
| 4829                          | CK-400 Small Hobby Knife         | 1        | 12.540,-        | 1              |
| 4830                          | CK-500 Large Hobby Knife         | 1        | 39.490,-        | 1              |
| 4883                          | Cutter CK S                      | 2        | 41.470,-        | 1 *            |
| 4953                          | CK 900 Hobby Knife - Rubber Grip | 1        | 74.030,-        | 1              |

### Art Knives and Cutting Knives

High quality stable cutting knife, solid material non slip holder and good handling, ideal to cut curve. Spare knives available. Also available rotary cutter and office scissors.

Pisau potong yang stabil, batang metal anti slip dan mantap di tangan, cocok untuk memotong kurva. Tersedia pisau cadangan.



4686



4829

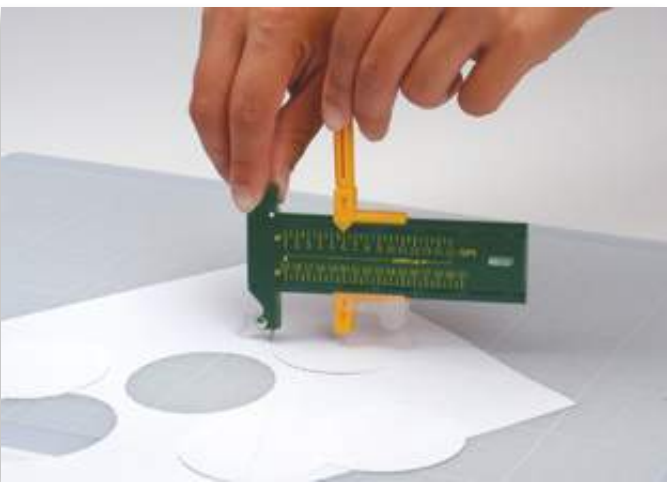

| Compass Cutter |                        |                 |                   |
|----------------|------------------------|-----------------|-------------------|
| Ref            | Description            | Unit Price (Rp) | Available Packing |
| 4709           | CK 1300 Compass Cutter | 96.580,-        | 1                 |

### Compass Cutter

Compass cutter for cutting on paper, film, soft plastic, etc. Circles from 10 - 300 mm diameter can be drawn and cut. Built in magazine with 5 spare blades and 2 pencils leads. Blister packed.

Pisau jangka untuk memotong kertas, film, plastic dan lainnya. Pisau sangat tajam terbuat dari baja berkualitas tinggi dan tidak mudah tumpul. Dilengkapi 5 pisau pengganti dan 2 buah isi pensil, sehingga dapat diubah menjadi seperti jangka biasa.



4833

**CK 600 Swivel Knife**

Swivel knife for cutting curved lines. Includes 10 spare blades. Blister-packed.



4800

**CK 100 Art Knife**

Art knife with 4 mm blade. Replaceable blade made of high-quality stainless steel. Blister-packed.



4801

**CK 200 Art Knife**

Art knife with 8 mm blade. Replaceable blade made of high-quality stainless steel. Blister-packed.

Spare Knife

| Ref  | Description                | QTY/ Set | Unit Price (Rp) | Packing |
|------|----------------------------|----------|-----------------|---------|
| 4811 | SK100 / for CK100 & CK600  | 1        | 32.230,-        | 1       |
| 4812 | SK200 / for CK200          | 1        | 50.710,-        | 1       |
| 4831 | SK300 / for CK400 & CK1000 | 10       | 53.900,-        | 1       |
| 4832 | SK400 / for CK500 & CK1100 | 10       | 72.380,-        | 1       |
| 4954 | SK900 / for CK900          | 5        | 50.710,-        | 1       |

# Spare Blades for Cutting Knives

**Spare Blades for Cutting Knives**

Complete refill for our cutting knives / cutters. High quality blades.

Mata pisau cadangan berkualitas tinggi untuk LINEX cutters.



4954



4832



4831



4811



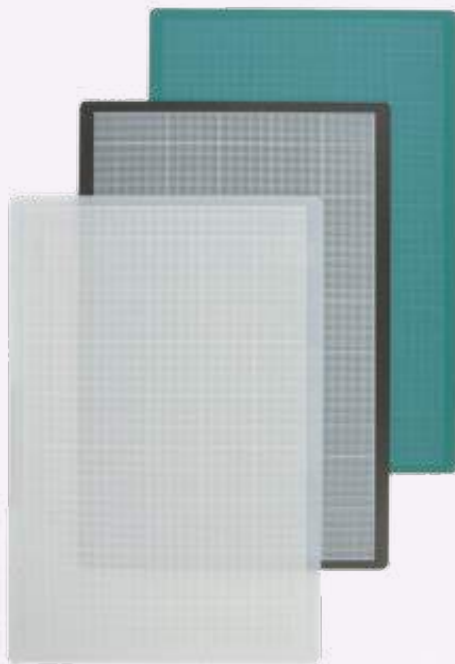

4812



# Cutting Mats

| Cutting Mats |                         |       |                 |         |
|--------------|-------------------------|-------|-----------------|---------|
| Ref          | Description             | Color | Unit Price (Rp) | Packing |
| 4803         | CM 2130 / 210 x 300 mm  | 04    | 137.280,-       | 1       |
| 4804         | CM 3045 / 300 x 450 mm  | 04    | 265.430,-       | 1       |
| 4805         | CM 4560 / 450 x 600 mm  | 04    | 523.270,-       | 1       |
| 4809         | CMT 4560 / 450 x 600 mm | 08    | 731.500,-       | 1*      |
| 4820         | CMB 3045 / 300 x 450 mm | 10    | 265.320,-       | 1*      |
| 4821         | CMB 4560 / 450 x 600 mm | 10    | 522.610,-       | 1*      |

Colours:     
08 10 04

## Cutting Mats

The mats are made with a soft layer on each side and a hard layer in the middle which makes cutting on both sides possible. One side provided with milimeter grid. All types are self healing. Material: 3 mm thick plastic.

Tatakan yang cocok untuk memotong kertas, sebagai alas pelindung agar pemotong tidak tembus & merusak meja. Tersedia 3 warna dan ukuran. Setiap tatakan dilengkapi petunjuk milimeter pada salah satu sisinya. Terbuat dari material plastik setebal 3mm yang memiliki kemampuan pemulihan sendiri terhadap bekas sayatan pada permukaan cutting mat.

## Cutting Mats Features

- 3 mm, semi-hard 3 layer sandwich type, 1 hard layer between 2 soft layers
- Selfhealing, antislip grid surface
- Can be used on both sides
- Protects table surface & protects the sharpness of the knife
- Can be used for cutting, as a mouse pad, and desk pad

## Cutting Mats Maintenance Guide

- Do not bend or roll
- Store on flat position
- Protect from sun and heat
- Avoid wedge & oblique cutting



**1202 S Ellipse Template Set**

With ink bosses  
 For pencil  $\frac{1}{4}$  0.5 mm and pen  $\frac{1}{4}$  0.5 mm  
 Contains 10 ellipse templates nos. 1215S-1260S with projections from 15 to 60° in 5° increments. Especially suited for axonometric drawing. Each template contains ellipses with major axes 2-15 mm in 1 mm increments, 16, 18, 20, 22, 24, 25, 28 mm as well as 30-50 mm in 5 mm increments - altogether 26 ellipses on each template. Set in case, with 10 pockets. Smallest template: 165 x 100 mm. Largest template: 205 x 100 mm. 0.9 mm green-transparent CP. 215 x 120 x 18 mm.

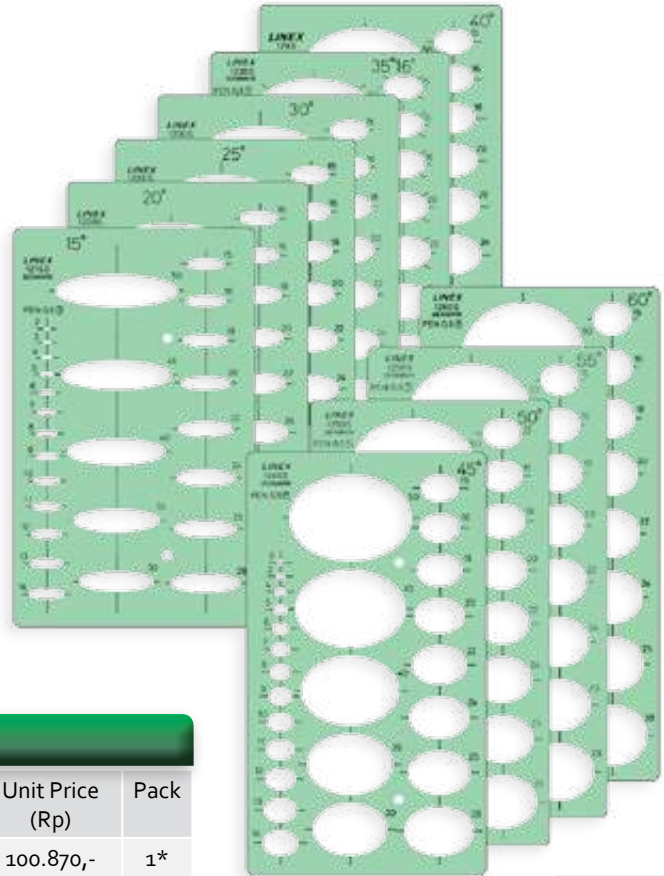

| Architecture Templates |                                                               |           |                 |      |
|------------------------|---------------------------------------------------------------|-----------|-----------------|------|
| Ref                    | Description                                                   | Size (mm) | Unit Price (Rp) | Pack |
| 5652                   | 1148 / 37 Arrow Templates                                     | 165 x 95  | 100.870,-       | 1*   |
| 5705                   | 1202S / Ellipse Template Sets (consists 10 Ellipse Templates) |           | 1.581.030,-     | 1*   |
| 5713                   | 1215S Ellipse Template                                        | 165 x 100 | 133.320,-       | 1*   |
| 5717                   | 1220S Ellipse Template                                        | 20        | 133.320,-       | 1*   |
| 5721                   | 1225S Ellipse Template                                        | 25        | 133.320,-       | 1*   |
| 5722                   | 1230S Ellipse Template                                        | 30        | 133.320,-       | 1*   |
| 5731                   | 1237S Architecture / 1 : 200 scale                            | 125 x 75  | 123.640,-       | 1*   |
| 5733                   | 1240S Ellipse Template                                        | 40        | 133.320,-       | 1*   |
| 5736                   | 1245S Ellipse Template                                        | 45        | 133.320,-       | 1*   |
| 5740                   | 1250S Ellipse Template                                        | 50        | 133.320,-       | 1*   |
| 5742                   | 1255S Ellipse Template                                        | 55        | 133.320,-       | 1*   |

**Architecture Templates**

For making architecture drawing symbol i.e. furniture, sanitary, installation, etc. Available scale 1 : 100, 1 : 200.

Untuk membuat simbol gambar arsitektur seperti furnitur, saniter, instalasi, dll. Tersedia skala 1 : 100, 1 : 200.



**Ink Bosses**

Manufactured in the material of the template, lifts the template 0.5 mm to prevent smudging of the ink lines. Reference indicated by number and S.

| Circle Template |                       |                 |                |
|-----------------|-----------------------|-----------------|----------------|
| Ref             | Description           | Unit Price (Rp) | Avail. Packing |
| 5832            | 1116s circle template | 107.360,-       | 1              |

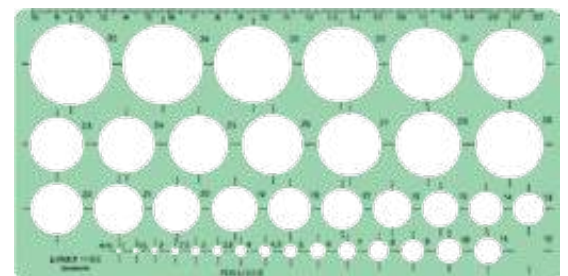

**Circle Template**

Templates for circles in designs and drawings. Also available other designs and templates.

Template lingkaran untuk berbagai keperluan gambar teknik. Tersedia juga templates dengan desain dan corak.

# Lettering Stencils

Linex range of lettering stencils for personal, school and commercial use. Quick and easy production of letters for filing, signs and other purposes. Ink risers prevent smudging. ISO type can be written with ISO graph; DIN can be written with variocrip. The letter height available from 2.5 mm to 10 mm. Made of clear green plastic material with lifted edge.

Lini produk Linex pembentuk abjad & karakter untuk penggunaan personal dan komersial. Dengan cepat & mudah membuat huruf untuk penanda, promo harga, pengumuman dsb. Jenis ISO dapat ditulis dengan ISO graph dan DIN dengan variocrip. Besar huruf tersedia dari 2.5 mm sampai dengan 10 mm. Terbuat dari jenis plastik hijau bening dengan tepi yang dinaikan untuk mencegah rembesnya tinta.

| Lettering Stencils |             |                 |                 |         |
|--------------------|-------------|-----------------|-----------------|---------|
| Ref                | Description | Scale           | Unit Price (Rp) | Packing |
| 5845               | Linex 7210  | ISO/DIN 10.0 mm | 149.820,-       | 1       |
| 5859               | Linex 8510  | 10mm            | 16.500,-        | 1       |
| 5861               | Linex 8520  | 20mm            | 37.290,-        | 1       |
| 5862               | Linex 8530  | 30mm            | 35.420,-        | 1       |
| 5863               | Linex 8550  | 50mm            | 113.410,-       | 1       |
| 5864               | Linex 85100 | 100mm           | 237.930,-       | 1       |
| 5865               | Linex 8500S | 10, 20, 30 mm   | 57.970,-        | 1       |
| 5866               | Linex 8620  | 20mm            | 34.540,-        | 1*      |
| 5867               | Linex 8630  | 30mm            | 55.770,-        | 1*      |
| 5868               | Linex 8720  | 20mm            | 23.760,-        | 1       |
| 5869               | Linex 8730  | 30mm            | 30.030,-        | 1       |
| 5870               | Linex 8820  | 20mm            | 39.160,-        | 1       |

5864

Size comparisson with regular size pen

**Linex Lettering Stencil 85100**  
 Large 100mm lettering stencil with upper case letters, numbers, symbols, and signs. Contains 10 parts of lettering stencils.  
 \* Pen not included







**Linex 30mm  
Lettering Stencil 8530**

Ideal For Personal, School And Commercial Use. Ink Risers Prevent Smudging. Quick And Easy Production Of Letters For Filing, Signs, etc. Upper Case Letters And Numbers. Standard Font, Letter Height 30Mm. \* Pen not included



**Linex 20mm  
Lettering Stencil 8520**

Ideal For Personal, School And Commercial Use. Ink Risers Prevent Smudging. Quick And Easy Production Of Letters For Filing, Signs, etc. Upper Case Letters And Numbers. Standard Font, Letter Height 30Mm. \* Pen not included



**Linex 10mm  
Lettering Stencil 8510**

Ideal For Personal, School And Commercial Use. Ink Risers Prevent Smudging. Quick And Easy Production Of Letters For Filing, Signs, etc. Upper Case Letters And Numbers. Standard Font, Letter Height 30Mm. \* Pen not included



# Technical Lettering Stencils

**Linex 7210  
Technical Lettering Stencil**

For lettering as neat as if printed. Made from high quality plastic, resistant to warping and breakage. Compliant with ISO 3098/1B, DIN6776/1B.

Clear green tinted material provides high contrast so even the finest lines are clearly visible. H-profile templates. Letter Size: 3.5mm

Technical Lettering Stencil

| Ref  | Description | Scale           | Unit Price (Rp) | Pack |
|------|-------------|-----------------|-----------------|------|
| 5845 | Linex 7210  | ISO/DIN 10.0 mm | 149.820,-       | 1    |

# Lettering Stencils

Linex range of lettering stencils for personal, school and commercial use. Quick and easy production of letters for filing, signs and other purposes. Ink risers prevent smudging. ISO type can be written with ISO graph; DIN can be written with variocrip. The letter height available from 2.5 mm to 10 mm. Made of clear green plastic material with lifted edge.

Lini produk Linex pembentuk abjad & karakter untuk penggunaan personal dan komersial. Dengan cepat & mudah membuat huruf untuk penanda, promo harga, pengumuman dsb. Jenis ISO dapat ditulis dengan ISO graph dan DIN dengan variocrip. Besar huruf tersedia dari 2.5 mm sampai dengan 10 mm. Terbuat dari jenis plastik hijau bening dengan tepi yang dinaikan untuk mencegah rembesnya tinta.

| Lettering Stencils |             |                 |                 |         |
|--------------------|-------------|-----------------|-----------------|---------|
| Ref                | Description | Scale           | Unit Price (Rp) | Packing |
| 5845               | Linex 7210  | ISO/DIN 10.0 mm | 149.820,-       | 1       |
| 5859               | Linex 8510  | 10mm            | 16.500,-        | 1       |
| 5861               | Linex 8520  | 20mm            | 37.290,-        | 1       |
| 5862               | Linex 8530  | 30mm            | 35.420,-        | 1       |
| 5863               | Linex 8550  | 50mm            | 113.410,-       | 1       |
| 5864               | Linex 85100 | 100mm           | 237.930,-       | 1       |
| 5865               | Linex 8500S | 10, 20, 30 mm   | 57.970,-        | 1       |
| 5866               | Linex 8620  | 20mm            | 34.540,-        | 1*      |
| 5867               | Linex 8630  | 30mm            | 55.770,-        | 1*      |
| 5868               | Linex 8720  | 20mm            | 23.760,-        | 1       |
| 5869               | Linex 8730  | 30mm            | 30.030,-        | 1       |
| 5870               | Linex 8820  | 20mm            | 39.160,-        | 1       |

### Linex Lettering Stencil 8500s - Set 10/20/30mm

This set of 3 Linex Lettering Stencils contains lettering heights of 10, 20 and 30mm for personal, school and commercial use. For quick and easy production of letters, numbers and symbols for filing, signs and other purposes, these stencils also feature an ink riser to prevent smudging.size.



Size comparisson with regular size pen



**Linex ITALIC  
Lettering Stencil 8820**

Italic font lettering stencils for personal, office, school and commercial use. Quick and easy production of letters, and ink risers prevent smudging. 20mm stencil.



**Linex DIGITAL  
Lettering Stencil 8730**

Digital style font lettering stencils for personal, office, school and commercial use. Quick and easy production of letters, and ink risers prevent smudging. 30mm stencil.



**Linex Old English  
Lettering Stencil 8620 & 8630**

Old English style lettering stencils for personal, office, school and commercial use. Quick and easy production of letters, and ink risers to prevent smudging. Available in 20mm & 30mm size.

\* Pen not included in all models

# Lettering Stencils

**Linex 8550 Lettering Stencil**

Ideal for personal, school or commercial use. Ink risers prevent smudging. Upper case letters and numbers. Standard font, letter height 50 mm. Contains 4 piece set



Two rubber strips ensure that the ruler lies firmly on the paper.



One rubber strip prevents the ruler from sliding.



When tilting the ruler, the rubber is lifted from the paper and the ruler slides smoothly on the acrylic rib.

# Super Ruler

| Super Ruler |             |                     |                 |         |
|-------------|-------------|---------------------|-----------------|---------|
| Ref         | Description | Length / Width (mm) | Unit Price (Rp) | Packing |
| 0878        | S-30 MI     | 300 / 34            | 110.330,-       | 1*      |
| 0880        | S-50 MI     | 500 / 38            | 193.930,-       | 1       |

## Super Ruler

With 2 bevels 

Our legendary Super Ruler has achieved international recognition and its resilient design still makes it an international best-seller. It includes a patented and unique slide/antislid principle, which makes it far more functional and efficient than traditional rulers. A built-in rubber strip grips the underlying surface and the ruler locks itself firmly in place. By slightly tilting the ruler, it is easily repositioned. The Super Ruler has found wide use as it is suitable for both drafting, measuring and following lines. Material: crystal-clear acrylic with green centre.

Model "MI" is divided in mm on a 0-30 cm scale on one side and is divided in inches on a 0-12 inch scale on the other side.



4814

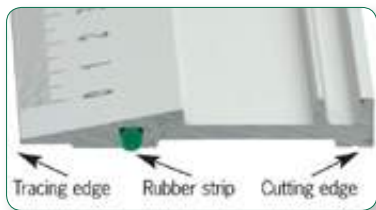

| Alluminium Ruler |             |                     |                 |         |
|------------------|-------------|---------------------|-----------------|---------|
| Ref              | Description | Length / Width (mm) | Unit Price (Rp) | Packing |
| 4813             | Alu 19100M  | 100 cm              | 385.880,-       | 1       |
| 4814             | Alu 1930M   | 30 cm               | 138.930,-       | 1       |
| 4816             | Alu 1950M   | 50 cm               | 235.840,-       | 1       |
| 4818             | Alu 1980M   | 80 cm               | 514.030,-       | 1       |

## Alluminium Ruler

Cutting ruler with bevel, special rubber strip on the underside to prevent from sliding when a cutting knife is used. Precision divided.

Garis aluminium untuk potong. Dilengkapi dengan strip karet pada bagian bawah penggaris untuk mencegah penggaris bergeser bila menggunakan cutter.

College Ruler

| Ref  | Description    | Length | Unit Price (Rp) | Packing |
|------|----------------|--------|-----------------|---------|
| o899 | Ruler Coll 130 | 30 cm  | 34.870,-        | 1       |
| o900 | Ruler Coll 140 | 40 cm  | 97.240,-        | 1       |

College Ruler

College Ruler material tinted plastic transparent. Made from black plastic. Penggaris sekolah dari bahan plastik berwarna gelap, transparan dan dikemas dalam kantong PVC.

Flat Scale

| Ref  | Description            | Scale                        | Unit Price (Rp) | Pack |
|------|------------------------|------------------------------|-----------------|------|
| o931 | 433 Flat Scale / 30 cm | 1:1:20:25:50:100:200:250:500 | 113.960,-       | 1    |

Flat Scale

With bevel and tracing edge, precision divided. Material glass clear Dunilon. Drawing and office ruler made of crystal clear acrylic. Penggaris bening dari bahan Dunilon dan akrilik bening dengan tepian untuk tinta dan pensil. Pembagian presisi.

School, Drawing and Office Ruler

| Ref  | Description       | Length | Unit Price (Rp) | Packing |
|------|-------------------|--------|-----------------|---------|
| o852 | Clear School 1030 | 30 cm  | 34.870,-        | 1       |
| o854 | Clear School 1050 | 50 cm  | 106.920,-       | 1       |
| o862 | Clear A 1530M     | 30 cm  | 86.240,-        | 1       |
| o864 | Clear A 1550M     | 50 cm  | 171.160,-       | 1       |

School, Drawing and Office Ruler

With bevel and tracing edge, precision divided. Material glass clear Dunilon. Drawing and office ruler made of Crystal clear Acrylic. Penggaris bening dari bahan Dunilon dan akrilik bening dengan tepian untuk tinta dan pensil. Pembagian presisi.

Word Processor Rulers

| Ref  | Description    | Size | Unit Price (Rp) | Packing |
|------|----------------|------|-----------------|---------|
| o884 | 1731 EDP Ruler | 12"  | 73.810,-        | 1*      |
| o885 | 1745 EDP Ruler | 18"  | 92.070,-        | 1*      |

Word Processor Rulers

Counting lines and characters, etc. Ideal for form layout using computer. Scale for character pitch and spacing. Penggaris Word-processing untuk layout cetakan dengan komputer. Menghitung garis serta karakter. Pembagian dalam karakter pitch dan spasi.

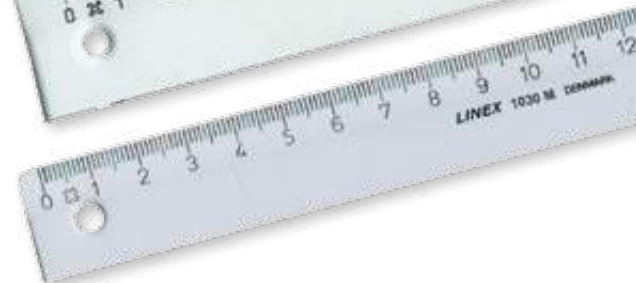

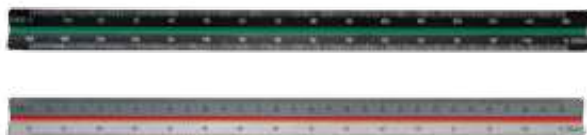

### Triangular Scale Ruler

| Ref  | Description             | Scale             | Unit Price (Rp) | Packing |
|------|-------------------------|-------------------|-----------------|---------|
| 0977 | Scale Ruler C321        | 1:20:25:50:75:125 | 123.090,-       | 1       |
| 0979 | Scale Ruler C323        | 1:2,5:5:10:20     | 123.090,-       | 1       |
| 0910 | Scale Ruler 371 / grey  | 1:20              | 190.960,-       | 1 *     |
| 0987 | Scale Ruler 361 / black | 1:20              | 184.140,-       | 1 *     |

#### Triangular Scale Ruler

For engineering & architectural drawing. Supplied in plastic sheath.  
 Penggaris skala untuk teknik dan arsitektur. Dilengkapi dengan sarung plastik.



0763

### Geometry Set Square

| Ref  | Description  | H / L      | Unit Price (Rp) | Packing |
|------|--------------|------------|-----------------|---------|
| 0763 | Linex 2616   | 110/160 mm | 60.170,-        | 1/10    |
| 0767 | Linex 2632   | 230/320 mm | 215.710,-       | 1/10    |
| 0795 | Linex 1616GH | 110/160 mm | 24.200,-        | 1/10 *  |
| 0796 | Linex 2621GH | 160/225 mm | 48.290,-        | 1/10    |

#### Geometry Set Square

Combine a ruler, a protractor and a drawing set square in a single device. With metric scale and yellow stripe\* to highlight opposite numbering.

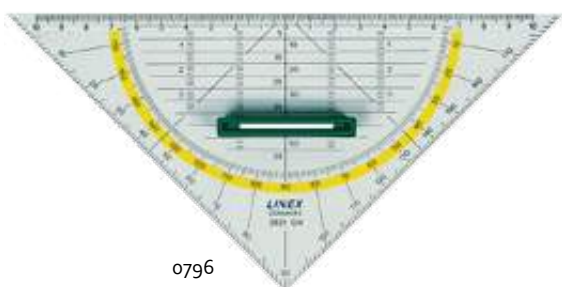

0796



0795



0767

Set Square

| Ref  | Description | Length    | Unit Price (Rp) | Packing |
|------|-------------|-----------|-----------------|---------|
| 0498 | A 4536 TFM  | 45 / 36cm | 168.850,-       | 1       |
| 0505 | A 6036 TFM  | 60 / 36cm | 175.120,-       | 1       |
| 0620 | D 4536 TFM  | 45 / 36cm | 98.230,-        | 1       |

**Set Square**

Made of high quality clear Dunilon or Acrylic material edge for pencils, ink drawing. Terbuat dari bahan Dunilon bening atau Akrilik, dipakai untuk menggambar dengan pensil atau tinta.

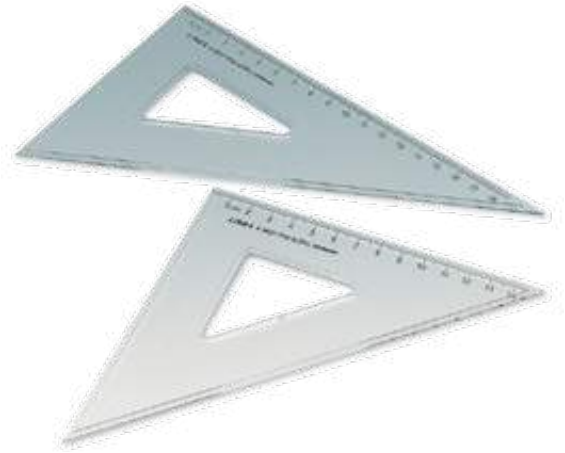

College Set Square 45° and 60°

| Ref  | Description | Scale   | Unit Price (Rp) | Packing |
|------|-------------|---------|-----------------|---------|
| 0650 | 45 Coll 425 | 16.5 cm | 110.330,-       | 1       |
| 0653 | 45 Coll 436 | 24.5 cm | 119.680,-       | 1       |
| 0654 | 60 Coll 625 | 23.5 cm | 114.950,-       | 1       |
| 0657 | 60 Coll 636 | 34.5 cm | 119.680,-       | 1       |

**College Set Square**

Tinted plastic material 45° and 60°. Penggaris segitiga untuk sekolah yang ekonomis dengan sudut 45 derajat dan 60 derajat.



College Set Square - Geo Set Square

| Ref  | Description                   | content, scale | Unit Price (Rp) | Packing |
|------|-------------------------------|----------------|-----------------|---------|
| 0770 | Linex Coll 216 Geo Set Square | 180°, 7-0-7 cm | 25.520,-        | 1       |

**College Set Square - Geo Set Square**

Made of crystal clear dunilon. Especially helpful when teaching Geometry and Drawing. Terbuat dari dunilon. Sangat berguna untuk mengajar Geometri dan Menggambar.



Black Board Set / White Board Set

| Ref  | Description                        | Unit Price (Rp) | Avail. Packing |
|------|------------------------------------|-----------------|----------------|
| 0792 | Blackboard / White Board Sets BB-S | 831.380,-       | 1set           |

# Black Board Set / White Board Set

## Black Board Set / White Board Set

A full range of blackboards drawing articles are moulded in yellow plastic, featuring pads on reverse to obtain better grip. The sets contains ruler 100 cm, Sets square 45/90, 30/60, Protractor 180, Compass 42 cm.

Seri perlengkapan papan tulis . Terbuat dari plastik berwarna kuning. Bantalan di bawah penggaris menjamin kemantapan dalam pemakaian dipapan tulis. Terdiri dari: penggaris 100 cm, segitiga 45/90, 30/60, Protractor 180, jangka 42 cm.



T Square Set

| Ref  | Description           | Unit Price (Rp) | Avail. Packing |
|------|-----------------------|-----------------|----------------|
| 2425 | Linex-T100MT Square   | 224.620,-       | 1              |
| 2426 | Linex-T120MT Square   | 878.900,-       | 1              |
| 4312 | Linex-D365PMIT Square | 349.910,-       | 1              |



## T Square Set

T - squares for Schools and drawings. With double tracing edge, material head and blade of crystal dunilon. For Ref 2425 and 2426 Removable head with wedge lock.

T - Squares untuk berbagai keperluan menggambar dan gambar tehnik. Terbuat dari bahan dunilon.



College Curve Set

| Ref  | Description    | Scale            | Unit Price (Rp) | Pack |
|------|----------------|------------------|-----------------|------|
| 4681 | Curve Set C103 | 310, 160, 130 mm | 100.760,-       | 1    |

**College Curve Set**

Tinted plastic material for college.  
Penggaris kurva terbuat dari bahan plastik transparan gelap.

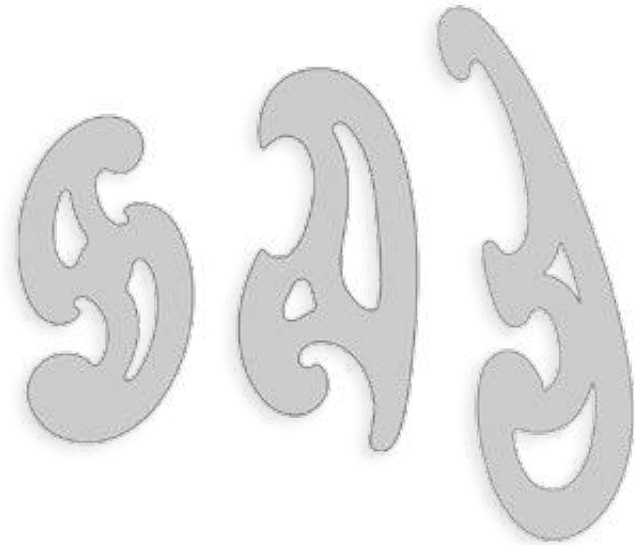

Flexible Curve

| Ref  | Description                  | Unit Price (Rp) | Available Packing |
|------|------------------------------|-----------------|-------------------|
| 2435 | Flexible Curve FC30 / 30 cm  | 122.089,-       | 1                 |
| 2437 | Flexible Curve FC50 / 50 cm  | 165.660,-       | 1                 |
| 2443 | Flexible Curve FCG30 / 30 cm | 140.800,-       | 1                 |
| 2445 | Flexible Curve FCG50 / 50 cm | 211.970,-       | 1                 |

**Flexible Curve**

Made of vinyl covering with lead core which secures the required curve. Suitable for drawing curves down to 15 mm Ø. Blister-packed.  
Ref 2443 & 2445 with cm-ruler on both sides.

Penggaris fleksibel, terbuat dari Vinyl, lentur dan dapat dibentuk sesuai kurva yang diperlukan sampai dengan 15 mm Ø. Dijual dalam kemasan blister. Ref 2443 & 2445 dilengkapi dengan penggaris cm pada kedua sisinya.

With tracing edges 



Drawing Tube

| Ref  | Description                 | Unit Price (Rp) | Available Packing |
|------|-----------------------------|-----------------|-------------------|
| 4848 | Linex DT-124 / 70cm (124cm) | 346.060,-       | 1                 |
| 4884 | Linex DT-74 / 40cm (74cm)   | 203.390,-       | 1                 |

**Drawing Tube**

Telescope Type. Delivered with strap. Length 70 cm - can be enlarged up to total length of 124 cm. Diameter 75 mm.

Tabung untuk membawa dan melindungi dokumen / gambar anda dari debu, kelembapan dan sinar matahari. Dilengkapi tali gantung pundak. Type 4848 Panjang 70 cm - dapat diperpanjang sampai dengan 124 cm, diameter 75 mm. Untuk Type 4884 diameter-nya 54 mm (5.5cm).

Colours:   
10



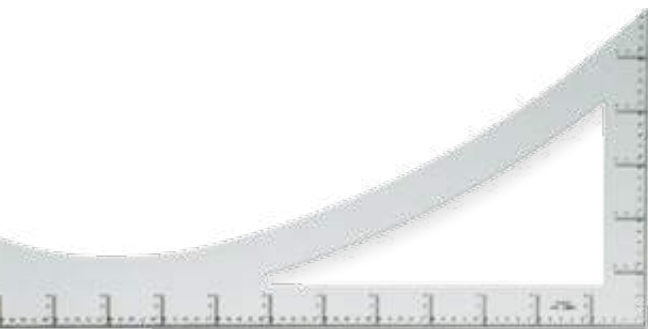

### Tailor Set Square

| Ref  | Description            | Unit Price (Rp) | Available Packing |
|------|------------------------|-----------------|-------------------|
| 0662 | 2960 Tailor Set Square | 1.045.660,-     | 1                 |

#### Tailor Set Square

Essential for any Tailors, amateur or professionals in their work with patterns. Ruler on 2 sides. Vertical graduation on both sides. Material: crystal-clear acrylic.

Sangat berguna dan cocok untuk penjahit, baik pemula atau ahli yang profesional dalam mengerjakan pola. Terbuat dari bahan akrilik bening.



### Eraser Shield

| Ref  | Description                | Unit Price (Rp) | Available Packing |
|------|----------------------------|-----------------|-------------------|
| 2471 | Linex ES-30 Erasing Shield | 43.450,-        | 1                 |

#### Eraser Shield

Made of the finest Stainless steel. 26 opening for easy erasing. Supplied on blister-card.

Terbuat dari besi baja anti karat. 26 tempat yang memudahkan anda menghapus pada bagian atau bentuk tertentu. Dijual dalam kemasan blister



### Office Pencil - HB

| Ref  | Description      | Unit Price (Rp) | Available Packing |
|------|------------------|-----------------|-------------------|
| 4862 | Pencil /grade HB | 50.160,-        | 12 Pcs/Box        |

#### Linex Office Pencil - HB

High Quality Linex Classic HB Pencil. Suitable for school & office use.

Pensil Linex HB berkualitas. Cocok untuk penggunaan di kantor & sekolah.

1529-00

| Drawing Pencils |                              |                 |                   |
|-----------------|------------------------------|-----------------|-------------------|
| Ref             | Description                  | Unit Price (Rp) | Available Packing |
| 1527-10         | 3001/E 0.5 Mechanical Pencil | 142.560,-       | 1*                |
| 1529-00         | 4001/E 0.5 Mechanical Double | 209.880,-       | 1*                |

### Drawing Pencils

New range of double push pencils. Lead grads 0.5, 0.7 rubber touch surface for good grip. Complete with erasers and cleaning needle.

Jenis pensil gambar baru, dengan mekanik dua langkah (mata dan isi). Untuk isi pensil 0.5, 0.7mm. Permukaan seperti karet untuk pegangan yang mantap. Lengkap dengan penghapus dan jarum pembersih.



| Mechanical Pencils |                               |                 |                   |
|--------------------|-------------------------------|-----------------|-------------------|
| Ref                | Description                   | Unit Price (Rp) | Available Packing |
| 1505-10            | 2000/ E 0.5 Black             | 129.030,-       | 1/10/100*         |
| 1507-00            | 2001/ E 0.5 Metal             | 164.780,-       | 1/10/100*         |
| 1527-10            | 3001/ E 0.5 Mechanical Pencil | 142.560,-       | 1*                |
| 1529-00            | 4001/ E 0.5 Mechanical Double | 209.880,-       | 1*                |

### Mechanical Pencils

Type 2000; 0.5 mm pencil, black, non slip hold with eraser, cleaning needle and lead grade indicator. Type 2001; 0.5 mm pencil, silver finish, non slip hold with eraser, cleaning needle and lead grade indicator.

Pensil mekanik Linex, tersedia dalam 2 warna yaitu hitam dan perak. Dilengkapi penghapus, serta pegangan yang tidak licin.



1507-00

| Quick Acting Bow Compass |                            |                 |                   |
|--------------------------|----------------------------|-----------------|-------------------|
| Ref                      | Description                | Unit Price (Rp) | Available Packing |
| 2371                     | Linex Compass Set 73 (A-E) | 228.690,-       | 1*                |

Colours:    
09 17

### Quick Acting Bow Compass

With extension bar. For circle up to 380 mm diameter with extension bar up to 650 mm diameter. Supply with extra lead and spareparts. Compass has two knee joint available in 5 attractive colours.

Jangka pas yang cepat dan tepat penyetelannya. Untuk lingkaran diameter 380 mm dengan lengan perpanjangan hingga 650 mm. Kedua lengan dapat ditekuk. Tersedia mata pensil.





## **LINEX** Nautical

Quality instruments for people  
who enjoy safe sailing.  
(available on request)

Used for Navigation Map and drawing coordinate on map  
Application for Sailor, Army, Search and Rescue, Navy, Airport, Airforce and Harbour.

Berfungsi untuk pembacaan peta navigasi dan pembuatan koordinat pada peta.  
Cocok untuk Pelaut, Angkatan bersenjata, Search and Rescue, Penerbangan / Angkatan Udara, Petugas Bandara, Syahbandar Pelabuhan, Sekolah Pelayaran.

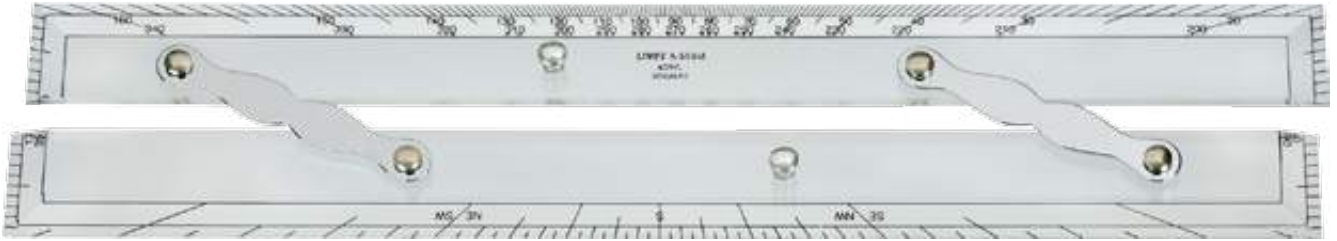

Parallel Rulers A618M & A612M

| Ref  | Description | Length / Thickness (mm) | Unit Price (Rp) | Pack |
|------|-------------|-------------------------|-----------------|------|
| o822 | A618M       | 450 / 6                 | 2.302.080,-     | 1*   |
| o823 | A621M       | 520 / 6                 | 2.449.150,-     | 1*   |

Parallel Rulers A618M & A612M

With bevels on all four sides. Springs built in the bearings ensure a smooth motion. Cork-discs on the underside prevent sliding. Divided in 360°. Material: crystal-clear acrylic. Links made of plated brass.

2802 Nautical Protractor

| Ref  | Description | Length / Width | Unit Price (Rp) | Pack |
|------|-------------|----------------|-----------------|------|
| o813 | Linex 2802  | 130/130 mm     | 214.720,-       | 1    |

2802 Nautical Protractor

With plain edge. Suitable for plotting course and bearing. Mat surface can be written on with pencil. Material: 1 mm transparent PETG. 130 x 130 mm.

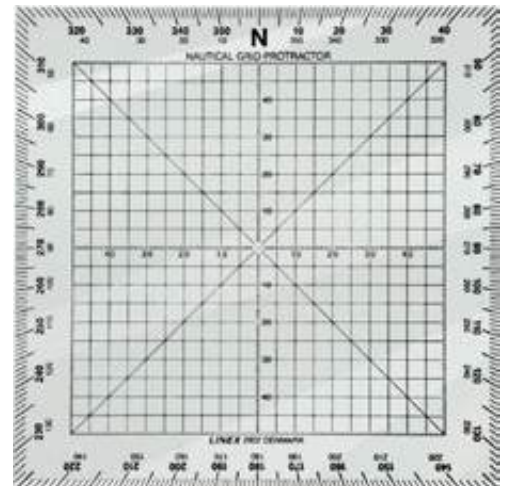

2810 Nautical Plotter

| Ref  | Description           | Unit Price (Rp) | Available Packing |
|------|-----------------------|-----------------|-------------------|
| o814 | Nautical Plotter 2810 | 517.550,-       | 1                 |

2810 Nautical Plotter

For plotting course and bearing. Direct reading against a variation scale. Ideal for use on chart boards. Divided degrees and guidelines. User instructions enclosed. Material: 1.5 mm transparent PETG. 140 x 140 mm base. 377 mm arm.

Untuk menetapkan arah serta bearing. Dapat langsung dibaca dengan skala variasi. Cocok dipakai dengan peta laut. Pembagian presisi untuk derajat dan arah tujuan. Instruksi untuk penggunaan tersedia. Material 1.5 mm, plastik transparan.





**2800MH Nautical Protractor**

| Ref  | Description | Hypotenuse | Cathetus | Thick-ness | Unit Price (Rp) | Pack |
|------|-------------|------------|----------|------------|-----------------|------|
| 0811 | 2800 MH     | 280 mm     | 200 mm   | 2.75 mm    | 180.070,-       | 1    |

**2800MH Nautical Protractor**

With plain edge and convenient handle. Precision divided degree and lines. Hypotenuse divided in millimeter. Material Crystal clear Dunilon.

Dengan kontur rata dan memiliki pegangan. Pembagian presisi dalam sudut, dan garis pembagian hypotenuse milimeter. Material Dunilon bening.

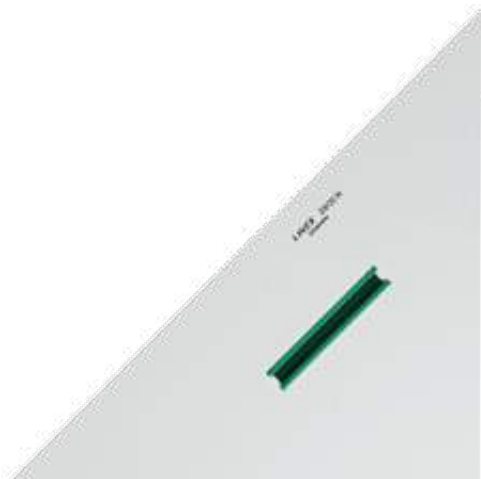

**2800H Nautical Set Square with Handle**

| Ref  | Description | Hypotenuse | Cathetus | Thick-ness | Unit Price (Rp) | Pack |
|------|-------------|------------|----------|------------|-----------------|------|
| 0812 | 2800 MH     | 280 mm     | 200 mm   | 2.75 mm    | 175.230,-       | 1    |

**2800H Nautical Set Square**

Same model as 2800 MH without degrees and lines for use as guide to the nautical protractor.

Model yang sama dengan 2800 MH tanpa derajat dan garis. Digunakan sebagai petunjuk atau digunakan bersama dengan Nautical protractor.



**2800M Nautical Protractor**

| Ref  | Description | Hypotenuse | Cathetus | Thick-ness | Unit Price (Rp) | Pack |
|------|-------------|------------|----------|------------|-----------------|------|
| 0810 | 2800 MH     | 280 mm     | 200 mm   | 2.75 mm    | 186.340,-       | 1    |

**2800M Nautical Protractor**

Plain edge precision divided degree and lines, hypotenuse divided in millimeter, material glass clear Dunilon.

Kontur rata, pembagian presisi dalam sudut, dan garis pembagian Hypotenuse milimeter. Material Dunilon bening.



**bino**

## Head Office

PT. Bino Mitra Sejati  
 Jl. Olympic Raya Blok A 8 - 9 Kawasan Industri  
 Sentul - Bogor 16810 Jawa Barat - Indonesia  
 Tel : (021) 875 7468  
 Fax : (021) 875 7248  
 E-mail : cs.bogor@bino.co.id  
 Website : www.bantex.co.id

### Jakarta

PT. Bino Mitra Sejati  
 Jl. Raya Boulevard Barat Blok LC 6/23  
 Kelapa Gading Permai, Jakarta 14240  
 Tel. (021) 4507929 / 30, 4535021  
 Fax. (021) 4503923, 4535022, 4516178  
 Email: cs.kelapagading@bino.co.id

PT. Bino Mitra Sejati  
 ITC Mangga Dua Lantai Dasar Blok E2  
 No. 45-54 Jakarta 14430  
 Tel. (021) 6017025 / 29 / 30, 6018264  
 Fax. (021) 6017027  
 Email: cs.manggadua@bino.co.id

PT. Bino Artomas  
 Jl. Pengadegan Timur Raya No. 5  
 Jakarta Selatan 12770  
 Tel. (021) 7973231, 7975631, 08119788824  
 Fax. (021) 7975586  
 Email: bantex\_artomas@yahoo.com

CV. Bino Arsitama  
 Villa Indah Permai Blok.D6 No.20 RT.003/RW.033  
 Kelurahan Teluk Pucung, Kecamatan Bekasi Utara,  
 Kota Bekasi 17121, Jawa Barat  
 Tel. (021) 8889 2966, 8889 2900, 8889 4081  
 Fax. (021) 4201277  
 Email: arsitama@hotmail.com  
 Email: arsitamabino@gmail.com

### Bekasi

PT. Bino Mitra Sejati  
 Delta Silicone Technology 2  
 Jl. Kaliandra 1 Blok F6 / 1M - Lippo Cikarang  
 Tel. (021) 8889 2966, 8889 2900, 8889 4081  
 Fax. (021) 89117668  
 Email: cs.cikarang@bino.co.id

### Banten

PT. Bino Mitra Sejati  
 Gudang Taman Tekno 2 BSD Sektor XI  
 Blok E2 / 8 Serpong - Banten  
 Tel. 021 75880170 / 71  
 Fax. 021 75880167  
 Email: cs.serpong@bino.co.id

### Bandung

CV. Pelita Kasih Mulia  
 Kopo Plaza B-6 Jl. Peta (Lingkar Selatan) Bandung  
 40232  
 Tel. (022) 6036650, 6071807, 6011848  
 Fax. (022) 6041281  
 Email: bantex@bdg.centrin.net.id

### Cirebon

CV. Pelita Kasih Mulia  
 Kesambi Regency KR. 8  
 Jl. Kesambi Raya Cirebon 45134  
 Tel. (0231) 200605, 209846  
 Fax. (0231) 242113  
 Email: bantex\_crb@yahoo.com

### Yogyakarta

PT. Bino Mitra Sejati  
 Jombor RT 01, RW.01, Jl. Jombor/Pokak, Jombor,  
 Cepre, Klaten Jawa Tengah

Jl. Nangka V, No.247 B, Karangnongko, RT.06,  
 RW.013, Maguwoharjo, Depok, Sleman, Yogyakarta.  
 Telp/Fax : (0274) 2805095  
 Email: cs.yogyakarta@bino.co.id

### Semarang

PT. Bino Mitra Sejati  
 Kawasan Industri Candi Blok 11 A 3  
 Gatot Subroto, Semarang  
 Telp. (024) 7627367 / 08112891226  
 Fax. (024) 7627367  
 Email: cs.semarang@bino.co.id

### Surabaya

PT. Bino Mitra Sejati  
 Jln. Raya Jemursari No.44 Surabaya  
 Telp. (031) 8484136-38, 8484142  
 Fax. (031) 8484139  
 Email : cs.surabaya@bino.co.id

PT. Bino Mitra Sejati  
 Pergudangan Gading Mutiara Permai  
 Jl. Ngasinan Blok F-1  
 Desa Kepatihan, Kec. Menganti, Gresik  
 Tel. (031) 7411550  
 Fax. (031) 7411553  
 Email: cs.benowo@bino.co.id

PT. Gading Murni  
 Jl. Tunjungan No. 27, Surabaya  
 Tel. (031) 5316340, 5316341  
 Fax. (031) 5315337

Toko Bintang Palapa  
 Jl. Tunjungan No. 33, Surabaya  
 Tel. (031) 5353074, 5323153  
 Fax. (031) 5316964  
 Email: b-palapa@mitra.net.id

### Bali

PT. Bino Mitra Sejati  
 Jl. Sekar Tunjung XI No.21 Denpasar - Bali  
 Tel. (0361) 466045, 085954131045  
 Fax. (0361) 466045  
 Email: cs.bali@bino.co.id

### Medan

PT. Mestika Makmur Persada Jaya  
 Jl. Sena No.23C & 25A Kel. Perintis,  
 Kec. Medan Timur  
 Tel. (061) 4145970, HP: 081310084202  
 Fax. (061) 4512282  
 Email: binomedan@gmail.com

### Manado

PT. Bino Mitra Sejati  
 Jl. Arnold Mononutu No. 304 Kel. Pakowa, Kec.  
 Wanea - Sulawesi Utara  
 Tel. (0431) 876313  
 Tel. 082220888687  
 Email: cs.manado@bino.co.id

### Batam

PT. Mulia Makmur Lestari  
 Komplek Century Park Blok D No.1,  
 Batam Centre - Indonesia  
 Tel. (62) 778 472223, 7418622 (Hunting)  
 Fax. (62) 778 472225  
 e-mail : mulia@mmlgroup.co.id  
 e-mail : purchase@mmlgroup.co.id

### Batam

PT. Batara Indah Mulia  
 Cammo Industrial Park Blok A2 No. 2 - 4,  
 Batam Centre  
 Tel. (62) 778 463078  
 email : cs.batam@bantex.co.id

### Samarinda

PT. Bino Mitra Sejati  
 Jl. HM. Ardans Ringroad 3 Rt. 01 No. 02  
 Kel. Samarinda Utara Kec. Sempaja Barat.  
 Telp. 085247047718, (0541) 2523584  
 Email: cs.samarinda@bino.co.id

### Palembang

PT. Bino Mitra Sejati  
 Jl. Torpedo  
 Ruko No. 9-10 RT.009 RW.003  
 Kel. 20 Ilir DII Kec Kemuning  
 Sekip Ujung Palembang  
 Telp. (0711) 5700154 / 081251559377  
 Fax. (0711) 5700202  
 email: cs.palembang@bino.co.id

### Jambi

PT. Bino Mitra Sejati  
 Jl. R.B.Siagian No.6 RT.12 Kel. Pasir Putih  
 Kec. Jambi Selatan Komplek PU Pasir Putih  
 Kota Jambi  
 Tel. 08373516627  
 email: cs.jambi@bino.co.id

### Pekan Baru

PT. Toba Makmur Perkasa  
 Jl. Jend. Sudirman No. 289-291, Pekanbaru  
 Tel. (0761) 22417, 25858, 36353  
 Fax. (0761) 36048  
 email: tobapku@tobadistribution.com

### Balikpapan

PT. Bino Mitra Sejati  
 Jl. Wonosari RT. 024 No.18 Kel. Gunung Sari Ilir,  
 Balikpapan Tengah  
 Tel. (0542) 420134  
 Tel. 081348893743, 087812005123  
 Fax. (0542) 420134  
 email: cs.balikpapan@bino.co.id

### Banjarmasin

CV. Batara Batuah  
 Jl. Pramuka Komplek Bersama No 18B RT 18 RW  
 002 Sungai Lutul Banjarmasin, Kalimantan Selatan  
 Tel. 0811518401, 085103338478, 085348250475  
 Fax. (0511) 325 16 86  
 email: batarabatuah@gmail.com

### Makassar

PT. Bino Mitra Sejati  
 Jln. Sultan Abdullah raya Ir.2 no. 1 Kel. Buloa, kec.  
 Tallo, kota makassar 90212  
 Tel. (0411) 8945908, 0821-9009-1566  
 Fax. (0411) 8943734  
 email: cs.makassar@bino.co.id

## Bantex Meraih 9 Penghargaan TOP BRAND (2011-2020)



**M**erek adalah salah satu aset terpenting dari perusahaan. Dari sudut pandang keuangan, merek bisa senilai puluhan kali nilai buku perusahaan. Dari sudut pandang yang lain, merek adalah antarmuka dan persentuhan antara konsumen dan perusahaan, ia merupakan deskripsi dari produk atau layanan yang ditawarkan perusahaan.

Fakta ini membuat manajemen merek sangat diperlukan. Dan dalam mengelola merek, tentu kita tidak bisa mengabaikan pengukuran dan benchmarking. Tahun ini, Frontier Consulting Group sekali lagi menerapkan indikator kekuatan merek yang disebut Top Brand Index (TBI). Top Brand Award adalah sebuah penghargaan terhadap merek-merek yang tergolong sebagai merek teratas.

Top Brand Index diukur dengan menggunakan 3 parameter, yaitu top of mind awareness (yaitu didasarkan atas merek yang pertama kali disebut oleh responden ketika kategori produknya disebutkan), last used (yaitu didasarkan atas merek yang terakhir kali digunakan/ dikonsumsi oleh responden dalam 1 re-purchase cycle), dan future intention (yaitu didasarkan atas merek yang ingin digunakan/ dikonsumsi di masa mendatang). Kriteria top didasarkan atas survei yang dilaksanakan oleh Frontier Consulting Group sejak tahun 2000.

PT Batara Indah, sebagai produsen dan pemegang merek Bantex kembali menerima penghargaan Top Brand Award 2020 untuk merek Bantex, di Hotel Mulia, Senayan, Jakarta. Penghargaan tersebut bagi Bantex merupakan penghargaan kesembilan, sejak pertama kali meraih penghargaan yang sama di 2011 silam.

Top Brand merupakan penghargaan yang sangat bergengsi dan juga merupakan simbolisasi pengakuan konsumen Indonesia terhadap kualitas produk Bantex yang selalu unggul. Penghargaan ini juga merupakan salah satu penghargaan yang dapat membantu para konsumen dan penikmat merek untuk mengindikasikan dan mempertimbangkan suatu produk.

Bantex meraih TOP BRAND AWARDS 2011, 2012, 2013, 2014, 2015, 2016, 2017, 2018, 2020 untuk kategori 'Filing Product'.



**Bantex**  
Organizing Made Easy



# Mengarsipkan Dokumen Dengan Efektif

**K**ondisi tempat kerja yang rapi dan teratur bisa membuat anda lebih bersemangat, dan tentunya meningkatkan produktivitas kerja. Salah satu cara memulainya adalah dengan meluangkan waktu beberapa menit untuk mengatur meja kerja anda. Sortir barang-barang yang perlu diletakan di atas meja kerja. Saat menata, pertimbangkan dengan seksama barang-barang apa saja yang sering digunakan, lalu letakan di posisi yang mudah dijangkau. Jangan lupakan buku, catatan, dan barang-barang lain yang dibutuhkan.

Penyimpanan dokumen di kantor harus dilakukan dengan sistematis sehingga apapun yang dicari dapat ditemukan dengan cepat. Meskipun jumlah dokumen Anda terhitung banyak, bila diatur dengan baik, anda tidak akan mengalami kesulitan menemukan



dokumen yang dibutuhkan. Dengan pengarsipan yang baik, anda menciptakan sebuah sistem akses dokumen yang cepat dan efisien.

Penyimpanan dan pengarsipan dokumen bisa disesuaikan dengan tata letak kantor anda. Misalnya, untuk memilah dokumen yang berada di meja, anda dapat menggunakan letter tray dan folder. Untuk dokumen yang berada di lemari khusus, anda dapat menggunakan ordner atau magazine file. Untuk dokumen terurai anda di filing cabinet, anda dapat menggunakan suspension file. Produk-produk media filing Bantex tersedia dalam beragam warna yang akan semakin memudahkan anda mencari, memisahkan dan mengkategorikan dokumen.



## Bantex Mendukung Pelestarian Alam Indonesia

**S**ebagai bentuk kepedulian dan dukungan terhadap upaya pelestarian alam, Bantex Indonesia bekerjasama dengan WWF - Indonesia dalam program NEW TREES. NEW TREES merupakan program rehabilitasi dan penyelamatan hutan Indonesia dengan menggabungkan metode penanaman secara tradisional dan kegiatan monitoring menggunakan teknologi geotag.

Penanaman pohon perdana telah dilakukan secara simbolis oleh Managing Director Bantex Indonesia, Bapak Kristanto Widjaja (berkaos hijau) pada hari Kamis, tanggal 31 Mei 2012, di Taman Nasional Ujung Kulon Pandeglang, Banten, Jawa Barat. Acara seremonial yang diadakan oleh Bantex Indonesia dan WWF Indonesia ini juga dihadiri oleh Pemkab Pandeglang dan Kepala Balai Taman Nasional Ujung Kulon.

Melalui program NEW TREES, diharapkan 7.000 hektar area hutan yang rusak di Sumatera, Kalimantan, Nusa Tenggara dan Papua dapat dihijaukan kembali dalam periode 5 tahun.

## Reference Number

| Ref<br>▼ | Page<br>▼ | Ref<br>▼    | Page<br>▼ | Ref<br>▼ | Page<br>▼ | Ref<br>▼    | Page<br>▼ | Ref<br>▼    | Page<br>▼ |
|----------|-----------|-------------|-----------|----------|-----------|-------------|-----------|-------------|-----------|
| 00001    | 161       | 0979        | 188       | 1451     | 10        | 2445        | 191       | 40011221503 | 140       |
| 00002    | 161       | 0987        | 188       | 1451V    | 12        | 2471        | 192       | 40011221505 | 140       |
| 00004    | 161       | 100100362   | 146       | 1452     | 12        | 3133        | 69        | 40011221510 | 140       |
| 00007    | 161       | 100100415   | 134       | 1453     | 10        | 3135        | 69        | 40011221561 | 140       |
| 00027    | 161       | 100101523   | 134       | 1465     | 10        | 3140        | 68        | 40011221809 | 140       |
| 00832    | 161       | 100101584   | 134       | 1465V    | 12        | 3140!       | 70        | 40011221819 | 140       |
| 01032    | 161       | 100101930   | 134       | 1465V07  | 15        | 3143        | 68        | 40011221821 | 140       |
| 01041    | 161       | 100102880   | 149       | 1465V25  | 15        | 3143!       | 70        | 40011221822 | 140       |
| 01223    | 167       | 100102931   | 136       | 1466     | 10        | 3145        | 68        | 40011221863 | 140       |
| 01224    | 167       | 100102938   | 136       | 1466V    | 12        | 3145!       | 70        | 4010        | 91        |
| 01225    | 167       | 100102994   | 149       | 1467     | 12        | 3180        | 68        | 4011        | 91        |
| 01226    | 168       | 100103453   | 146       | 1468     | 12        | 3180!       | 70        | 4012        | 91        |
| 01263    | 164       | 100103627   | 136       | 1505-10  | 193       | 3183        | 68        | 41090       | 123       |
| 01264    | 164       | 100103741   | 136       | 1507-00  | 193       | 3183!       | 70        | 41390       | 123       |
| 01271    | 164       | 100104067   | 149       | 1527-10  | 193       | 3185        | 68        | 41490       | 123       |
| 01273    | 164       | 100104296   | 146       | 1529-00  | 193       | 3185!       | 70        | 4150        | 49        |
| 01274    | 164       | 100104329   | 149       | 1542     | 27        | 3147        | 68        | 4151        | 49        |
| 01276    | 164       | 100105213   | 134       | 1544     | 27        | 3153        | 88        | 4160        | 49        |
| 01277    | 164       | 100105331   | 136       | 1562     | 26        | 3155        | 72        | 4161        | 49        |
| 01278    | 164       | 100105406   | 136       | 1564     | 26        | 3156        | 72        | 4162        | 49        |
| 01279    | 164       | 10073521001 | 141       | 1593     | 27        | 3163        | 68        | 4163        | 49        |
| 01280    | 164       | 10073521003 | 141       | 1594     | 27        | 3164        | 68        | 41990       | 123       |
| 01281    | 164       | 10073521005 | 141       | 1595     | 27        | 3165        | 72        | 4205        | 45        |
| 01282    | 164       | 10073521010 | 141       | 1596     | 27        | 3166        | 72        | 4206        | 48        |
| 01283    | 164       | 10073521061 | 141       | 1660     | 27        | 3170        | 73        | 4209        | 41        |
| 01285    | 164       | 10073521209 | 141       | 1666     | 80        | 3174        | 71        | 1328        | 42,43     |
| 01286    | 164       | 10073521219 | 141       | 1667     | 80        | 3175        | 71        | 4211        | 45        |
| 01288    | 164       | 10073521221 | 141       | 1729     | 51        | 3176        | 71        | 4240        | 45        |
| 01289    | 164       | 10073521222 | 141       | 1778     | 50        | 3180        | 68        | 4312        | 190       |
| 01292    | 164       | 10073521263 | 141       | 1788     | 51        | 3180!       | 70        | 4681        | 191       |
| 01295    | 164       | 10294       | 166       | 18510.62 | 112       | 3181        | 70        | 4686        | 177,178   |
| 02001    | 166       | 10305       | 174       | 18510.63 | 112       | 3187        | 68        | 4709        | 178       |
| 02409    | 164       | 10370       | 168       | 18510.64 | 112       | 3197        | 130       | 4800        | 177,178   |
| 02414    | 164       | 10372       | 168       | 18510.65 | 112       | 3210        | 75        | 4801        | 177,178   |
| 02418    | 164       | 10600       | 166       | 2016     | 53        | 3220        | 100       | 4803        | 180       |
| 02419    | 164       | 10608       | 165       | 2017     | 53        | 3230        | 74        | 4804        | 180       |
| 02425    | 163       | 10968       | 167       | 2021     | 52        | 3231        | 74        | 4805        | 180       |
| 02427    | 163       | 1101        | 151       | 2022     | 54,67     | 3260        | 76        | 4809        | 180       |
| 02428    | 163       | 1102        | 151       | 2023     | 54        | 3261        | 76        | 4811        | 179       |
| 02429    | 163       | 11134       | 175       | 2032     | 53        | 3301        | 23        | 4812        | 179       |
| 02430    | 163       | 1130        | 23        | 2034     | 52        | 3302        | 23        | 4813        | 186       |
| 02431    | 163       | 1132        | 23        | 2035     | 52        | 3393        | 69        | 4814        | 186       |
| 02433    | 163       | 11792.00    | 77        | 2035EW   | 52        | 3395        | 69        | 4816        | 186       |
| 02434    | 163       | 1201        | 152       | 2036     | 53,67     | 3420        | 75        | 4818        | 186       |
| 02435    | 163       | 12013       | 54        | 2037     | 53,67     | 3430        | 99        | 4820        | 180       |
| 02436    | 163       | 12512       | 163       | 2040     | 52        | 3431        | 99        | 4821        | 180       |
| 0498     | 189       | 12516       | 163       | 2042     | 52        | 3432        | 132       | 4829        | 177,178   |
| 0505     | 189       | 12517       | 163       | 2044     | 52        | 3450        | 103       | 4830        | 177,178   |
| 0620     | 189       | 1265.10     | 22        | 2045     | 52        | 3451        | 103       | 4831        | 179       |
| 0650     | 189       | 1301        | 152       | 2046     | 52        | 3455        | 103       | 4832        | 179       |
| 0653     | 189       | 1302        | 152       | 2050     | 57        | 3460        | 78,81     | 4848        | 191       |
| 0654     | 189       | 1311        | 25        | 2051     | 52        | 3470        | 78,81     | 4862        | 113,192   |
| 0657     | 189       | 1311!07     | 25        | 2070     | 55        | 3490        | 78,81     | 4883        | 178       |
| 0662     | 192       | 1312        | 25        | 2071     | 55        | 3600        | 97        | 4884        | 191       |
| 0763     | 188       | 1324        | 33        | 2079     | 53        | 3601        | 97        | 4953        | 177,178   |
| 0767     | 188       | 1325        | 32        | 2084     | 67        | 3602        | 94        | 4954        | 179       |
| 0770     | 189       | 1326        | 33        | 2090     | 55        | 3603        | 96        | 542190      | 123,128   |
| 0792     | 190       | 1327        | 32        | 2093     | 56        | 3607        | 132       | 5503        | 66        |
| 0795     | 188       | 1328        | 40,43     | 2094     | 56        | 3608        | 130       | 5504        | 66        |
| 0796     | 188       | 1329        | 40,43     | 2095     | 56        | 3610        | 102       | 5507        | 67        |
| 0810     | 196       | 1334        | 31        | 2140     | 56        | 3611        | 92        | 5508        | 67        |
| 0811     | 196       | 1336        | 31        | 2159     | 57        | 3612        | 132       | 5513        | 66        |
| 0812     | 196       | 1361        | 25        | 2191     | 56,85     | 400045810   | 139       | 5514        | 66        |
| 0813     | 195       | 1361!07     | 25        | 22.024   | 175       | 400047653   | 143       | 5517        | 67        |
| 0814     | 195       | 1362        | 25        | 22.025   | 175       | 400047655   | 143       | 5518        | 67        |
| 0822     | 195       | 1391        | 25        | 22.121   | 175       | 400047656   | 143       | 55601       | 125       |
| 0823     | 195       | 1391!07     | 25        | 22.124   | 175       | 400049397   | 139       | 5591        | 127       |
| 0852     | 187       | 1392        | 25        | 22.125   | 175       | 400049430   | 139       | 5592        | 127       |
| 0854     | 187       | 1401-01     | 19        | 2236     | 102       | 400051203   | 144       | 5596        | 127       |
| 0862     | 187       | 1401-10     | 19        | 2242     | 102       | 400051204   | 144       | 5599        | 127       |
| 0864     | 187       | 1402-10     | 19        | 2245     | 102       | 400053009   | 139       | 5652        | 181       |
| 0878     | 186       | 1403-10     | 19        | 2245P    | 102       | 400053150   | 139       | 5705        | 181       |
| 0880     | 186       | 1441        | 18        | 2246     | 101       | 400053151   | 139       | 5713        | 181       |
| 0884     | 187       | 1441B5      | 18        | 2247     | 130       | 400053152   | 139       | 5717        | 181       |
| 0885     | 187       | 1443        | 18        | 2371     | 193       | 400053153   | 139       | 5721        | 181       |
| 0899     | 187       | 1446        | 16        | 2425     | 190       | 400053154   | 139       | 5722        | 181       |
| 0900     | 187       | 1447        | 16        | 2426     | 190       | 400055726   | 151       | 5731        | 181       |
| 0910     | 188       | 1448        | 16        | 2435     | 191       | 400065616   | 139       | 5733        | 181       |
| 0931     | 187       | 1450        | 10        | 2437     | 191       | 400080787   | 150       | 5736        | 181       |
| 0977     | 188       | 1450V       | 12        | 2443     | 191       | 40011221501 | 140       | 5740        | 181       |

Reference Number

| Ref<br>▼ | Page<br>▼ |
|----------|-----------|
| 5742     | 181       |
| 5832     | 181       |
| 5845     | 182,184   |
| 5859     | 182,184   |
| 5861     | 182,184   |
| 5862     | 182,184   |
| 5863     | 182,184   |
| 5864     | 182,184   |
| 5865     | 182,184   |
| 5866     | 182,184   |
| 5867     | 182,184   |
| 5868     | 182,184   |
| 5869     | 182,184   |
| 5870     | 182,184   |
| 6003     | 63        |
| 6005     | 63        |
| 6006     | 63        |
| 6010     | 63        |
| 6013     | 63        |
| 6015     | 63        |
| 6016     | 63        |
| 6017     | 63        |
| 6018     | 63        |
| 6022     | 63        |
| 6032     | 63        |
| 6043     | 60        |
| 6045     | 60        |
| 6050     | 60        |
| 6051     | 60        |
| 6052     | 60        |
| 6059     | 60        |
| 6203     | 61        |
| 6205     | 62        |
| 6206     | 62        |
| 6210     | 62        |
| 6211     | 62        |
| 6212     | 62        |
| 6213     | 62        |
| 6215     | 62        |
| 6218     | 62        |
| 6219     | 62        |
| 6222     | 63        |
| 6223     | 63        |
| 6233     | 65        |
| 6235     | 65        |
| 6240     | 65        |
| 6241     | 65        |
| 6242     | 65        |
| 6245     | 65        |
| 6250     | 65        |
| 6259     | 65        |
| 70101    | 128       |
| 7400     | 87        |
| 7401     | 87        |
| 7410     | 87        |
| 7415     | 85        |
| 7422     | 86        |
| 7423     | 53,86     |
| 7425     | 85        |
| 7426     | 85        |
| 7440     | 86        |
| 7441     | 85        |
| 7445     | 87        |
| 7455     | 84        |
| 7456     | 87        |
| 7456-1   | 175       |
| 7460     | 86        |
| 77301    | 125       |
| 77701    | 125       |
| 8000     | 154       |
| 8000M    | 154       |
| 8001     | 35        |
| 8001-00  | 105       |
| 8001-01  | 105       |
| 8001-02  | 105       |
| 8001-03  | 105       |
| 8001-04  | 105       |
| 8002-08  | 35        |
| 8003     | 104       |
| 8005_00  | 109       |

| Ref<br>▼ | Page<br>▼ |
|----------|-----------|
| 8005     | 104       |
| 8006     | 104       |
| 8007     | 104       |
| 8008     | 104       |
| 8009     | 104       |
| 8013     | 93        |
| 8014     | 93        |
| 8015     | 93        |
| 8025     | 38        |
| 8026     | 39        |
| 8027     | 39        |
| 8028     | 39        |
| 8030     | 38        |
| 8031     | 38        |
| 8032     | 52        |
| 8035     | 52        |
| 8040     | 52        |
| 8042     | 52        |
| 8044     | 52        |
| 8045     | 52        |
| 8046     | 52        |
| 8051     | 52        |
| 8052     | 22        |
| 8053     | 22        |
| 8054     | 22        |
| 8060     | 86        |
| 8062     | 22        |
| 8063     | 22        |
| 8070     | 30        |
| 8071     | 30        |
| 8072     | 36        |
| 8073     | 36        |
| 8075     | 130       |
| 8116     | 113       |
| 8152     | 22        |
| 8153     | 22        |
| 8154     | 22        |
| 8162     | 22        |
| 8163     | 22        |
| 8205     | 108       |
| 8210-00  | 109       |
| 8211-00  | 109       |
| 8212     | 21        |
| 8212-00  | 109       |
| 8213     | 21        |
| 8214     | 20        |
| 8215     | 21        |
| 8216     | 21        |
| 8221     | 20        |
| 8222     | 21        |
| 8223     | 21        |
| 8224     | 20        |
| 8225     | 21        |
| 8226     | 21        |
| 8242     | 21        |
| 8243     | 21        |
| 8252     | 21        |
| 8253     | 21        |
| 8262     | 21        |
| 8263     | 21        |
| 8322     | 21        |
| 8342     | 21        |
| 8352     | 21        |
| 8362     | 21        |
| 8422     | 21        |
| 8442     | 21        |
| 8452     | 21        |
| 8512     | 24        |
| 8515     | 24        |
| 8521     | 24        |
| 8522     | 24        |
| 8523     | 24        |
| 8540     | 30        |
| 8541     | 30        |
| 8542     | 24        |
| 8543     | 24        |
| 8552     | 24        |
| 8553     | 24        |
| 8562     | 24        |
| 8563     | 24        |

| Ref<br>▼ | Page<br>▼ |
|----------|-----------|
| 8600     | 37        |
| 8601     | 37        |
| 8602     | 61        |
| 8603     | 61        |
| 8605     | 24        |
| 8607     | 34,65     |
| 8608     | 34,65     |
| 8609     | 35        |
| 8610     | 60        |
| 8611     | 34,65     |
| 8622     | 24        |
| 8642     | 24        |
| 8648     | 126       |
| 8649     | 126       |
| 8652_08  | 126       |
| 8652     | 24        |
| 8662     | 24        |
| 8722     | 24        |
| 8742     | 24        |
| 8752     | 24        |
| 8762     | 24        |
| 8808-10  | 174       |
| 8808-50  | 174       |
| 8810     | 95        |
| 8811     | 95        |
| 8815     | 47        |
| 8816_10  | 48        |
| 8817_10  | 50        |
| 8818     | 44        |
| 8819     | 44        |
| 8820_10  | 71        |
| 8821_10  | 71        |
| 8843     | 52        |
| 8843_08G | 52        |
| 31401    | 70        |
| 8845     | 79        |
| 8849-02  | 21        |
| 8849-03  | 21        |
| 8850     | 113       |
| 8851     | 124       |
| 8852     | 124       |
| 8853     | 124       |
| 8854     | 124       |
| 8855     | 124       |
| 8856     | 124       |
| 8857     | 124       |
| 8858_08  | 129       |
| 8859_08  | 128       |
| 8860_08  | 129       |
| 8861_08  | 129       |
| 8863     | 115       |
| 8864     | 115       |
| 8865     | 115       |
| 8866     | 115       |
| 8870_00  | 107       |
| 8870_01  | 107       |
| 8870_02  | 107       |
| 8871     | 106       |
| 8872     | 59        |
| 8873     | 59        |
| 8874     | 58        |
| 8875     | 59        |
| 8876     | 58        |
| 8877     | 58        |
| 8878     | 98        |
| 8879     | 98        |
| 8900     | 156-158   |
| 8901     | 156-158   |
| 8904     | 158       |
| 8905     | 158       |
| 8908     | 159       |
| 8910     | 158       |
| 8920     | 90        |
| 8921     | 90        |
| 9300     | 120       |
| 9303     | 121       |
| 9306     | 121       |
| 9319_00  | 122       |
| 9328     | 120       |
| 9329     | 120       |

| Ref<br>▼ | Page<br>▼ |
|----------|-----------|
| 9330     | 119       |
| 9331     | 117       |
| 9332     | 117       |
| 9340     | 116       |
| 9342     | 116       |
| 9343     | 116       |
| 9355     | 119       |
| 9356     | 118       |
| 9360     | 118       |
| 9361     | 118       |
| 9362     | 118       |
| 9750_07  | 128       |
| 9751_07  | 128       |
| 9811     | 83        |
| 9815     | 83        |
| 9820     | 112       |
| 9826     | 82        |
| 9830     | 111       |
| 9841     | 110       |
| 9842     | 110       |
| 9851     | 89        |
| 9860     | 89        |
| 9862     | 82        |
| 9863     | 82        |
| 9870     | 83        |
| 9872     | 83        |
| A084     | 46        |
| A085     | 47        |
| A116     | 46        |
| A125     | 46        |
| A126     | 28        |
| A127     | 28        |
| A128     | 28        |
| A135     | 28        |
| A141     | 29        |
| A142     | 29        |
| A143     | 29        |
| AF1010   | 171       |
| AF1010E  | 171       |
| AF1030   | 171       |
| AF1030E  | 171       |
| AF1040   | 171       |
| AF1070   | 171       |
| AF1070E  | 171       |
| AF1090   | 171       |
| AF1090E  | 171       |
| AF1120   | 171       |
| AF1120E  | 171       |
| AF1130   | 171       |
| AF1210   | 171       |
| AF1210E  | 171       |
| AF1230   | 171       |
| AF990    | 171       |
| AF990E   | 171       |
| E27592   | 77        |
| E27595   | 77        |
| E31414   | 91        |
| E31416   | 91        |
| E31418   | 91        |
| E41403   | 73        |
| E42414   | 73        |
| E42416   | 73        |
| E42418   | 73        |
| E84410   | 81        |
| P352_07  | 128,159   |
| P353_07  | 128,159   |
| P36100   | 159       |
| RA00001  | 169       |
| RA00002  | 169       |
| RA00832  | 169       |
| RA01032  | 169       |
| RA01224  | 169       |
| RA01225  | 169       |
| RA01226  | 169       |
| RA01271  | 169       |
| RA01273  | 169       |
| RA01274  | 169       |
| RA01278  | 169       |
| RA01281  | 169       |
| RA01283  | 169       |

| Ref<br>▼ | Page<br>▼ |
|----------|-----------|
| RA01285  | 169       |
| RA02001  | 169       |
| RA02409  | 169       |
| RA02414  | 169       |
| RA02419  | 169       |
| RA02425  | 163       |
| RA02427  | 163       |
| RA02431  | 163       |
| RA12512  | 163       |
| RB2035EW | 52        |



● **Bino Sales Coverage**



**PT Bino Mitra Sejati** - Jakarta Outlet:  
Jl. Raya Boulevard Barat Blok LC6 / 23  
Kelapa Gading Permai - Jakarta 14240  
Tel: (021) 4507929 - 30, 4535021  
Fax: (021) 4503923, 4535022, 4516178  
E-mail: info@bino.co.id

**PT. Bino Mitra Sejati** - Head Office:  
Kawasan Industri Sentul Jl. Olympic Raya  
Blok A 8 - 9 Sentul - Bogor  
Tel: (021) 875 7468 (hunting)  
Fax: (021) 875 7248  
E-mail: info@bantex.co.id  
Website: www.bantex.co.id

**Bantex Customer Care**  
E-mail: customercare@bantex.co.id  
Phone/WA: 0811-1125-468

## About Us

Bino has been established since 1986 as a manufacturing and trading company for office stationery products. Bino is licensed to manufacture high quality office supplies under the Bantex brand. Bantex is a very well-known brand for office stationery in Europe. They have their own factory and have given their licenses to distribute and to manufacture their products under the Bantex brand to worldwide distributors in more than 70 countries spreading over the six continents, including Bino in Indonesia.

We have made continuous improvements in our product quality and distribution system which enable us to give better service to our customers. We specialize in the manufacture and distribution of the high quality office stationery products. The bino management's policies will go along in conformity with our motto: quality and service are our commitment.

Bino deals in international brand stationery products and each product is the leader in its market. We distribute Bantex, Elba, Linex, APLI, Lyra, Xyron and some other superior brands of the office stationery products. We have made expansions and investments in an effort to deliver the highest level of service to our customers. Our head office and distribution center, that have an area of 25,000 square meters, are located in the Sentul Industrial Estate. The operations of this distribution center will increase our service capability to guarantee the customer satisfaction.

## Tentang Kami

Bino didirikan sejak tahun 1986 sebagai pabrikan dan perusahaan perdagangan dalam bidang peralatan kantor. Bino memiliki lisensi untuk memproduksi peralatan kantor yang bermutu tinggi dengan merek Bantex. Bantex merupakan sebuah merek peralatan kantor yang sangat terkenal di Eropa. Mereka memiliki pabrik sendiri dan telah memberikan lisensi untuk mendistribusi dan memproduksi produk-produk mereka dengan merek Bantex kepada distributor yang berada di lebih dari 70 negara yang tersebar di enam benua, termasuk Bino di Indonesia.

Kami telah mengadakan penyempurnaan yang berkesinambungan dalam mutu produk dan sistem distribusi yang memungkinkan kami untuk memberikan pelayanan yang lebih baik kepada para pelanggan. Bino memiliki spesialisasi dalam memproduksi dan mendistribusi peralatan kantor yang bermutu tinggi.

Bino menjual peralatan kantor dengan merek internasional dan setiap produknya merupakan pemimpin dalam pasarnya masing-masing. Kami mendistribusikan Bantex, Elba, Linex, APLI, Lyra, Xyron dan beberapa merek unggulan lainnya untuk peralatan kantor. Kami telah mengadakan ekspansi dan investasi dalam usaha untuk memberikan tingkat pelayanan yang terbaik kepada para pelanggan. Kantor pusat dan pusat distribusi kami seluas 25.000 meter persegi terletak di Kawasan Industri Sentul. Dengan dioperasikannya pusat distribusi ini akan meningkatkan kemampuan pelayanan kami dalam menjamin kepuasan pelanggan.

